

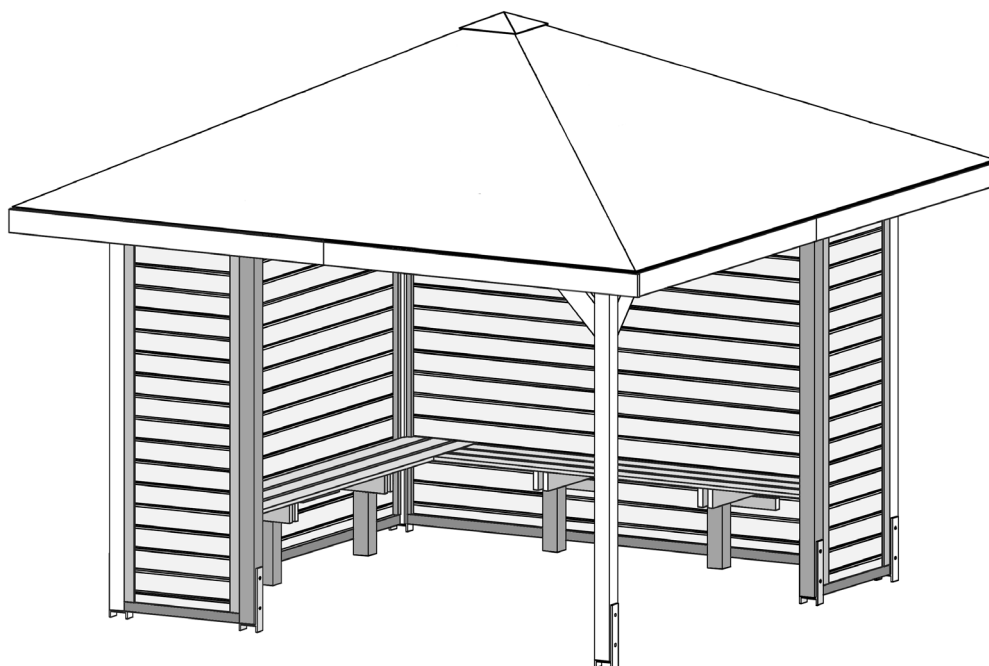

MONTAGE-, BEDIENUNGS- UND WARTUNGSANLEITUNG

| | |
|----|---|
| en | ASSEMBLY, USER AND MAINTENANCE INSTRUCTIONS |
| fr | NOTICE DE MONTAGE, D'UTILISATION ET D'ENTRETIEN |
| it | ISTRUZIONI DI MONTAGGIO, USO E MANUTENZIONE |



Ergänzungsbausatz Schutzlaube

Art.-Nr. 651.0200.38.00
651.0200.29.00

Stand 2012

- de -

**Sehr geehrte Kundin, sehr geehrter Kunde,
danke, dass Sie sich für ein weka – Produkt entschieden haben.**

- Lesen Sie diese Anleitung vor dem Aufbau bitte vollständig durch, um Montagefehler oder Beschädigungen zu vermeiden.
- **WICHTIG !**
Prüfen Sie bitte sofort anhand der Packliste, ob das weka-Produkt vollständig und unbeschädigt bei Ihnen angekommen ist.
- Bitte vernichten Sie die Packliste erst nach Ablauf der Garantiezeit. Diese Liste dient Ihnen zur Kontrolle auf Vollständigkeit der Einzelteile und ist mit dem Kaufbeleg aufzubewahren. Eventuelle Beanstandungen können mit Hilfe dieser Liste problemlos behoben werden.
- Die Pos.-Nummern der Packliste stimmen nicht mit den Pos.-Nummern folgender Montageanleitung überein.
- Wir empfehlen Ihnen die Montage mit 2 Personen durchzuführen.
- Zur Verhütung von Unfällen ist zu vermeiden, daß sich Kinder während der Montage in unmittelbarer Nähe befinden.
- Weiterentwicklungen im Sinne des technischen Fortschritts behalten wir uns vor. So können geringfügige Abweichungen in den Darstellungen entstehen.
- Verpackungsmaterial nicht einfach wegwerfen! Papier-, Pappe- und Wellpappeverpackungen, sowie Kunststoffverpackungsteile sollten in die entsprechenden Sammelbehälter gegeben werden.

Empfehlungen

- Bitte bohren Sie alle Schraubverbindungen vor, um Beschädigungen an den Holzteilen zu vermeiden! Folgendes Zeichen macht Sie während der Anleitung nochmals darauf aufmerksam:

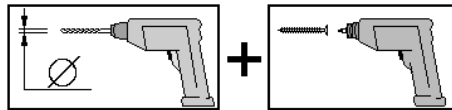

- Schützen Sie das Holz vor stundenlanger, direkter Sonneneinwirkung oder Feuchtigkeit.
- Holz ist ein Naturprodukt. Verschiedenartige Färbungen, Äste und Rißbildung sind normal und haben keinen Einfluß auf die Statik.

Werkzeug

Folgendes Werkzeug sollten Sie vor Beginn der Montage zurecht gelegt haben.

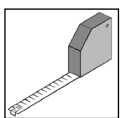

Bandmaß

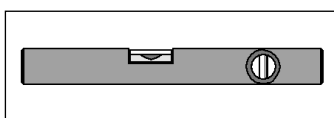

Wasserwaage

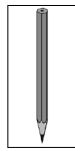

Bleistift

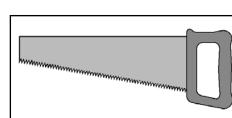

Säge

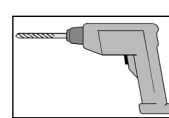

Bohrmaschine

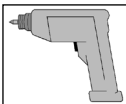

Elektroschrauber

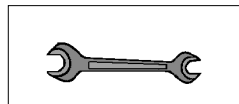

Schraubenschlüssel

Holzschutz

Das Produkt besteht aus dem natürlichen Rohstoff Holz. Dies macht regelmäßig ausreichende Holzschutzmaßnahmen zwingend erforderlich. Für die fachgerechte Holzschutzbehandlung wenden Sie sich bitte an einen Holzschutzfachmann. Holzschutzmaßnahmen sind vom Kunden in eigener Verantwortlichkeit durchzuführen. Ohne vorschriftsmäßigen Holzschutz kann keine Gewährleistung übernommen werden. Bitte beachten Sie auch die diesbezüglichen Bestimmungen in unseren Garantieerklärungen.

Wir wünschen Ihnen gutes Gelingen und viel Freude an Ihrem weka-Produkt.

- en -

Dear customer

Thank you very much for choosing a weka product.

- Read these instructions through completely before assembling your product in order to avoid errors in assembly or damage.
- **IMPORTANT**
Please use the enclosed packing list to check immediately that your weka product has been delivered complete and intact.
- Please do not dispose of the packing list before the guarantee period has expired. This list enables you to check that all the individual parts are present. It should be retained along with the proof of purchase. Any complaints which may arise can probably be easily rectified with this list. The item numbers on the packing list do not correspond to the item numbers in the following assembly instructions.
- We recommend that 2 people carry out the assembly.
- In order to prevent accidents, we recommend that children are kept out of the direct vicinity during assembly.
- We reserve the right to make further technological developments. This means that there may be minor deviations in the illustrations.
- Please do not simply throw away the packaging material. Paper, card and corrugated board as well as plastic packaging materials should be placed in the correct collection containers.

RECOMMENDATIONS

- Please drill pilot holes for all screw connections to avoid damaging the wood. The following symbol in the instructions will indicate when this is necessary:

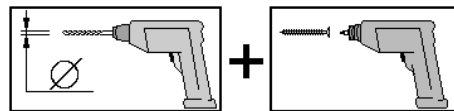

- Protect the wood from hours of direct sunlight and moisture.
- Wood is a natural product. Fluctuations in colour, knots and cracks are normal and have no influence on the statics.

TOOL

You should have the following tools to hand before beginning assembly. (Not supplied.)

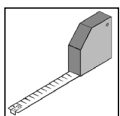

Spring tape measure

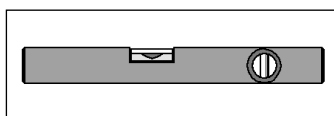

Spirit level

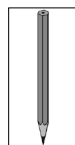

Pencil

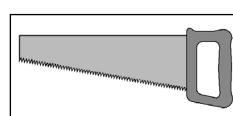

Mitre saw/hand disk saw

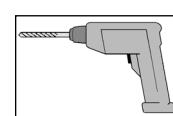

Drill

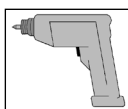

Electric screwdriver

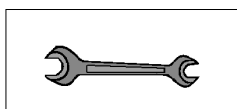

Spanner

Wood protection

The product is made from natural timber, for which regular and adequate wood preservation measures are obligatory. Please contact a wood preservation expert for information on professional preservation measures.

Wood preservation is to be carried out by the customer at his own risk. No guarantee can be given in the event of wood preservation not carried out in accordance with the instructions. Please also note the provisions relating to this in our guarantee.

We hope you have a successful installation and wish you many happy hours enjoying your weka product.

- fr -

Chère Cliente, cher Client

Nous vous remercions d'avoir choisi un produit weka.

- Lisez entièrement la présente notice avant de procéder à l'assemblage afin d'éviter les erreurs et les dommages.
- **IMPORTANT !**
Veillez vérifier immédiatement, à l'aide de la liste des pièces, si le produit weka est arrivé complet et en bon état.
- Ne détruisez la liste des pièces qu'une fois la garantie écoulee. Cette liste vous permet de vérifier si les pièces détachées sont complètes et doit être conservée avec le justificatif d'achat. Elle vous permettra de faire valoir aisément d'éventuelles réclamations. Les numéros de pos. de la liste des pièces ne sont pas identiques aux numéros de pos. de la présente notice de montage.
- Nous vous recommandons d'effectuer le montage à 2 personnes.
- Afin de prévenir tout accident, éviter la présence d'enfants à proximité durant le montage.
- Nous nous réservons le droit d'apporter aux produits des modifications dans le cadre de l'évolution technique. De légères différences sont par conséquent possibles par rapport aux illustrations.
- Ne pas jeter simplement le matériel d'emballage! Les emballages en papier, carton et carton ondulé doivent être déposés dans le container de tri correspondant.

RECOMMANDATIONS

- Pré-percez tous les assemblages vissés afin d'éviter d'endommager les éléments en bois! Ceci vous est rappelé par le symbole suivant dans la notice:

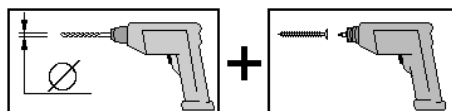

- Évitez d'exposer le bois au soleil ou à l'humidité pendant des heures.
- Le bois est un produit naturel. Les différentes colorations, les nœuds et les fissures sont normaux et n'ont aucun effet sur la tenue statique.

Outil

Pour le montage, nous vous recommandons de préparer les outils suivants.
(N'est pas compris dans la fourniture!)

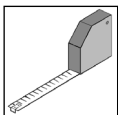

Décimètre à ruban

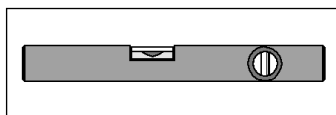

Niveau à bulle

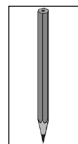

Crayon

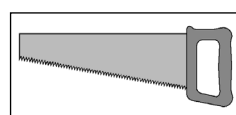

Scie à denture fine

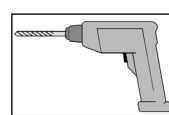

Perceuse

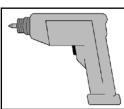

visseuse
électrique

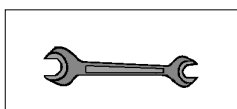

Clé

Protection du bois

Cet article est en bois brut naturel. Il est impératif d'entretenir et de protéger le bois régulièrement. Veuillez vous renseigner auprès d'un spécialiste du bois pour connaître les traitements appropriés.

Les mesures de protection du bois sont à effectuer par le client, sous sa propre responsabilité. Aucune garantie ne peut être accordée si le bois n'a pas été protégé selon les règles. Veuillez également vous reporter aux dispositions correspondantes de nos déclarations de garantie.

Nous vous souhaitons beaucoup de plaisir avec votre produit weka !

- it -

Egregi clienti,
ci congratuliamo con voi per avere scelto un prodotto weka.

- Prima del montaggio leggete con cura le presenti istruzioni al fine di evitare errori di montaggio o danni.
- **IMPORTANTE !**
Controllate subito con l'ausilio della lista di imballaggio che il prodotto weka sia stato fornito completo e senza danni.
- Vi preghiamo di conservare la lista di imballaggio solo alla scadenza del periodo di garanzia. Questa lista serve per controllare la completezza della fornitura e deve essere conservata insieme allo scontrino. Con l'ausilio della lista è possibile risolvere eventuali reclami. I numeri di posizione della lista di imballaggio non corrispondono con i numeri di posizione delle seguenti istruzioni di montaggio.
- Raccomandiamo di eseguire il montaggio in 2 persone.
- Per scongiurare eventuali incidenti tenere lontano i bambini dal luogo di montaggio.
- Ci riserviamo di apportare modifiche ai fini del progresso tecnologico. Per tale motivo è possibile che nelle rappresentazioni vengano a crearsi lievi differenze.
- Non gettare via il materiale di imballaggio! La carta, il cartone normale e ondulato cosiccome gli imballaggi in plastica devono essere smaltiti negli appositi contenitori di raccolta.

RACCOMANDAZIONI

- Per evitare danni agli elementi in legno si raccomanda di preforare tutti i punti di avvitaggio a vite! Il presente simbolo richiama la vostra attenzione su tale particolare nel corso delle istruzioni:

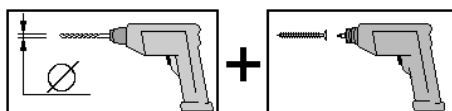

- Proteggete il legno dall'irradiazione solare diretta e dall'umidità prolungate.
- Il legno è un prodotto naturale. Differenti irregolarità cromatiche, la ramificazione e la crepatura sono da considerarsi normali e non hanno alcuna influenza sulla statica.

Utensile

Prima di iniziare con il montaggio tenere a portata di mano i seguenti utensili.
(Non compreso nella fornitura!)

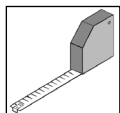

metro a nastro

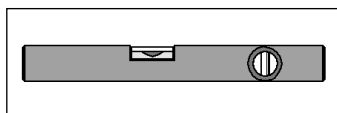

livella ad acqua

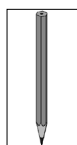

Matita

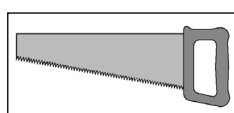

sega fine

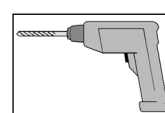

trapano

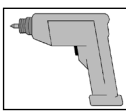

avvitatore
elettrico

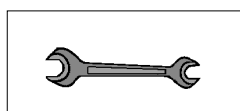

chiave

Protezione del legno

Il prodotto è composto dalla materia prima naturale del legno che rende le misure di protezione del legno assolutamente necessarie. Per il trattamento di protezione del legno a regola d'arte rivolgersi ad un esperto di protezione del legno. Le misure di protezione del legno devono essere eseguite dal cliente sotto la sua responsabilità. Senza protezione del legno prescritta non può essere assunta nessuna garanzia. Osservare anche le disposizioni al riguardo nelle nostre dichiarazioni di garanzia.

In bocca al lupo con il montaggio e buon divertimento con il vostro prodotto weka!

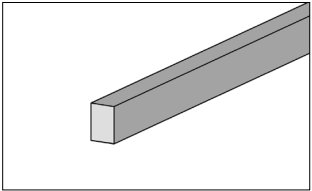
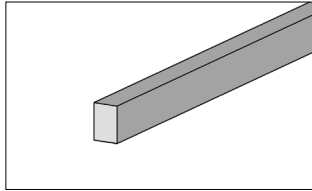
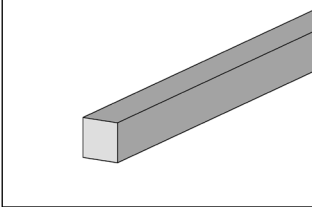
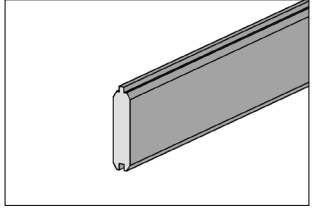
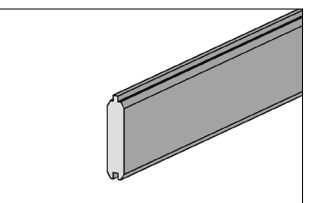
| Pos | Bild | Abmessung | 651.0200.29.00 | 651.0200.38.00 |
|-----|---|------------------------------------|----------------|----------------|
| ① |  | 50 / 70 / 2850 50 / 70 / 1990 | 2 | 2 |
| ② |  | 50 / 70 / 700 | 2 | 2 |
| ③ |  | 90 / 90 / 2030 | 2 | 2 |
| ④ |  | 28 / 121 / 2850 28 / 121 / 1990 | 34 | 34 |
| ⑤ |  | 28 / 121 / 695 | 34 | 34 |

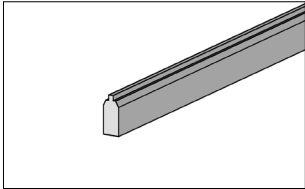
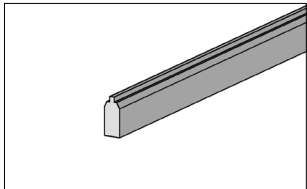
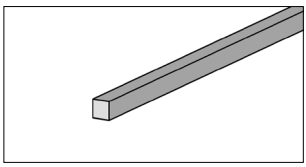
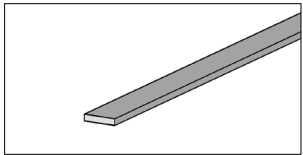
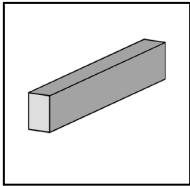
| Pos | Bild | Abmessung | 651.0200.29.00 | 651.0200.38.00 |
|-----|---|----------------------------------|----------------|----------------|
| 6 |  | 28 / 63 / 2850 28 / 63 / 1990 | 2 | 2 |
| 7 |  | 28 / 63 / 695 | 2 | 2 |
| 8 |  | 28 / 28 / 2160 | 8 | 8 |
| 9 |  | 11 / 58 / 2150 | 8 | 8 |
| 10 |  | 40 / 60 / 380 | 7 | 7 |

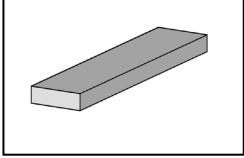
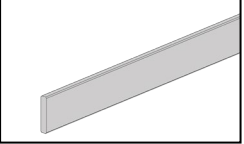
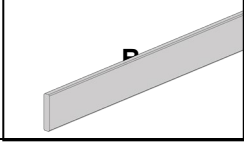
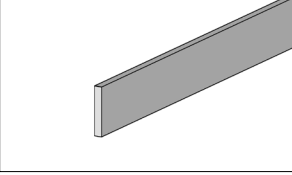
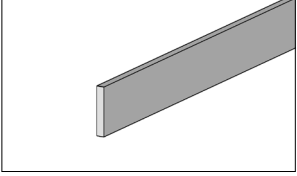
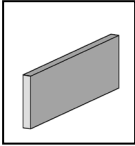
| Pos | Bild | Abmessung | 651.0200.29.00 | 651.0200.38.00 |
|-----|---|------------------------------------|----------------|----------------|
| 11 |  | 30 / 100 / 450 | 8 | 8 |
| 12 |  | 18,5 / 96 / 450 | 4 | 4 |
| 12 |  | 18,5 / 96 / 354 | 8 | 8 |
| 13 |  | 20 / 120 / 2980 20 / 120 / 2140 | 3 | 3 |
| 14 |  | 20 / 120 / 2492 20 / 120 / 1810 | 3 | 3 |
| 15 |  | 20 / 120 / 400 | 1 | 1 |

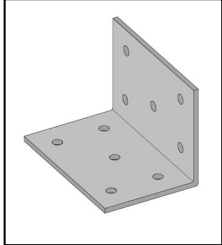
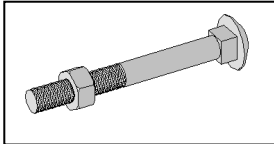
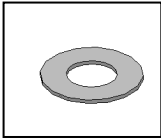
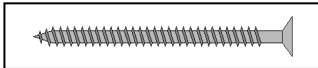
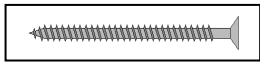
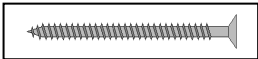
| Pos | Bild | Abmessung | 651.0200.29.00 | 651.0200.38.00 |
|-----|---|--------------|----------------|----------------|
| 16 |  | 40 / 60 / 60 | 4 | 4 |
| 17 |  | M10 x 80 | 14 | 14 |
| 18 |  | M10 | 14 | 14 |
| 19 |  | 5,0 x 80 | 45 | 45 |
| 20 |  | 4,0 x 60 | 60 | 60 |
| 21 |  | 4,0 x 50 | 325 | 325 |

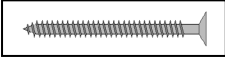
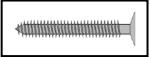
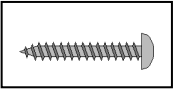
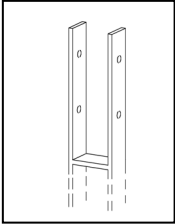
| Pos | Bild | Abmessung | 651.0200.29.00 | 651.0200.38.00 |
|-----|---|-------------------------------------|----------------|----------------|
| 22 |  | 4,0 x 40 | 50 | 50 |
| 23 |  | 3,5 x 35 | 60 | 60 |
| 24 |  | 5,0 x 35 | 40 | 40 |
| |  | Nicht im Lieferumfang enthalten! | 2 | 2 |

Vor Beginn!

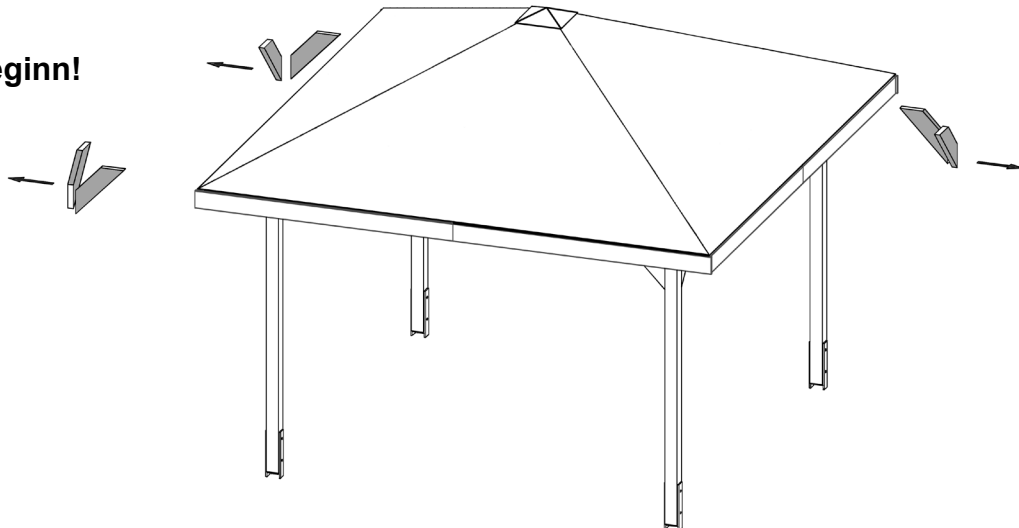

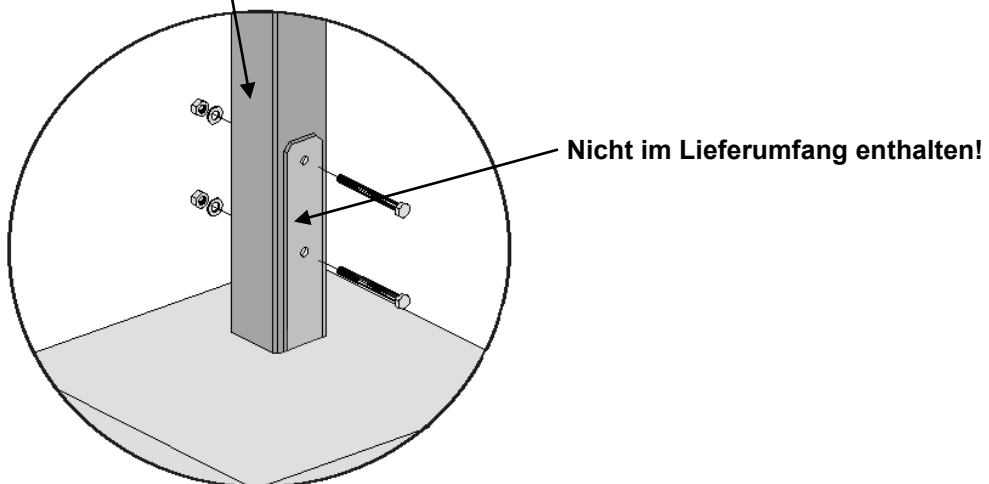
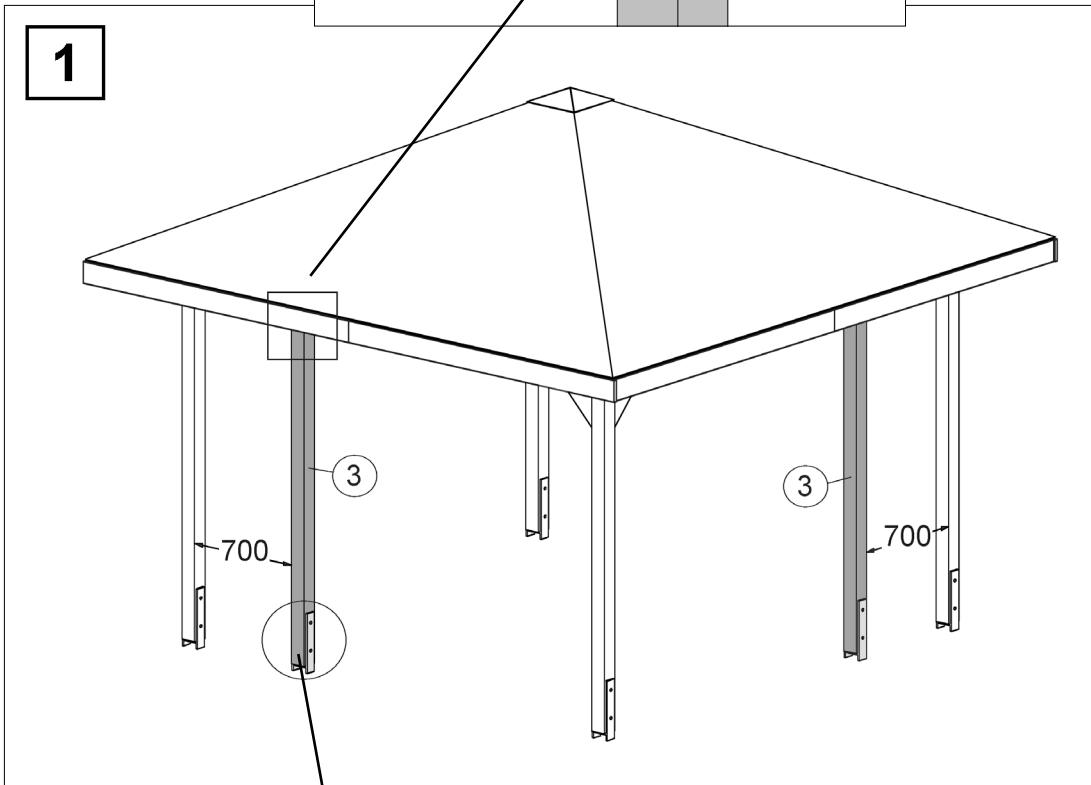
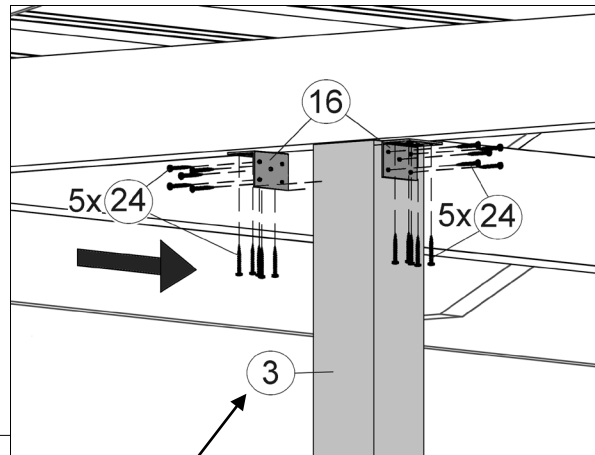
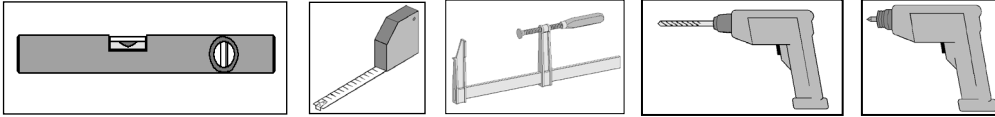

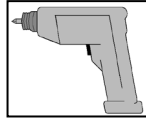
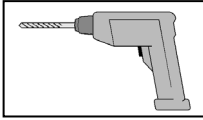
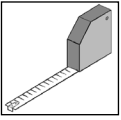

2

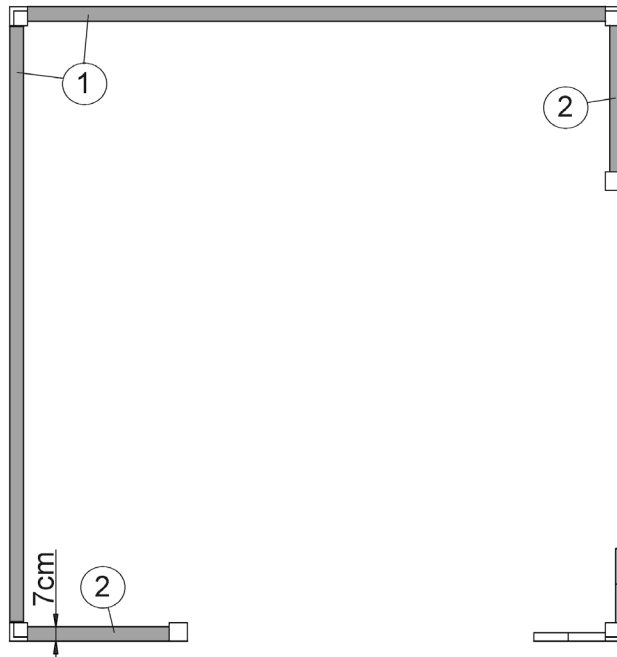
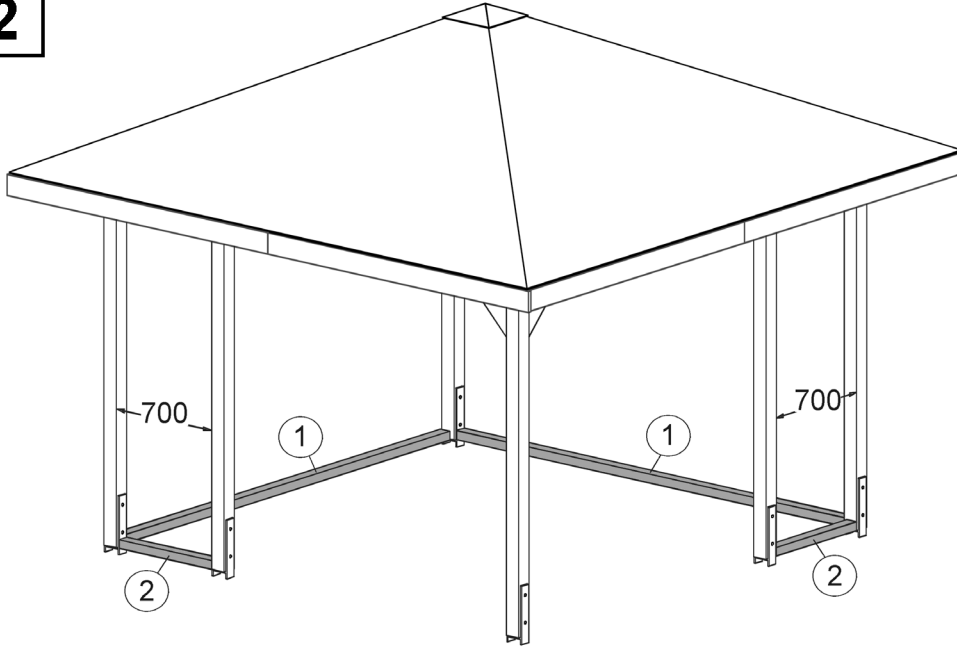

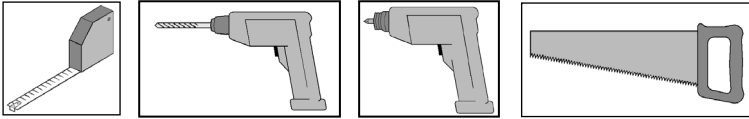

3

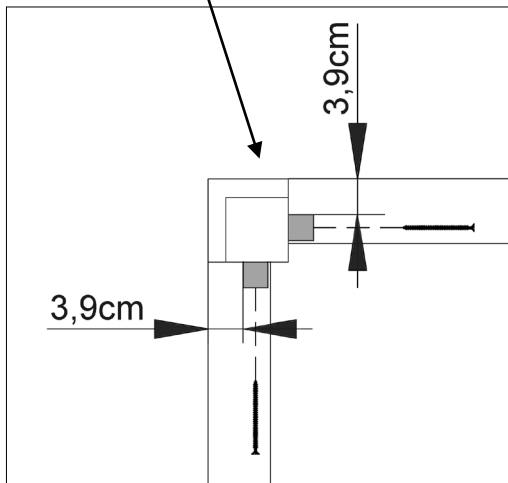
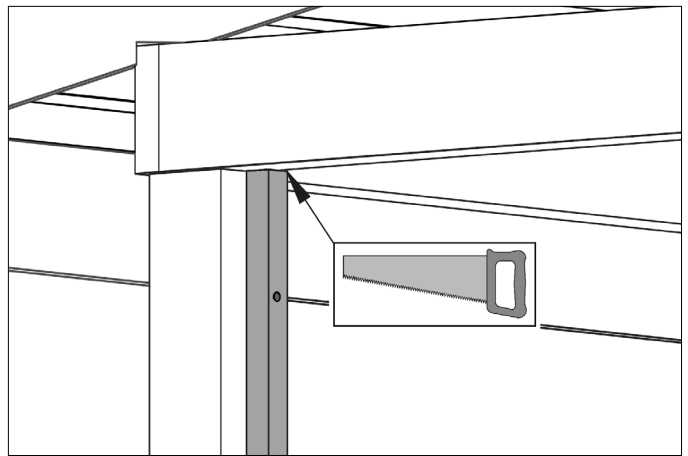
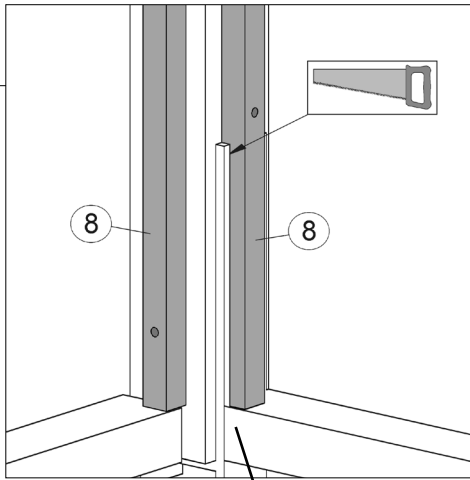
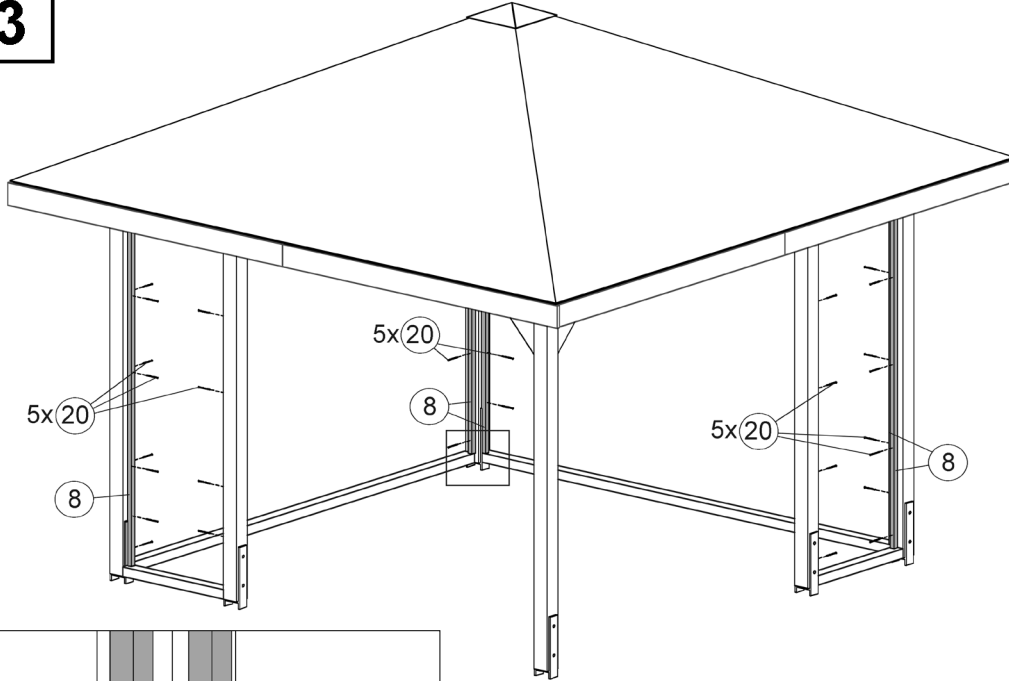

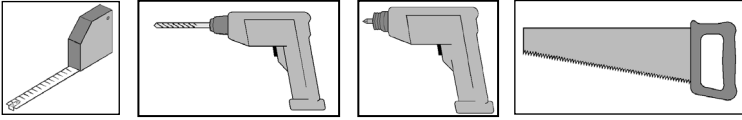

4

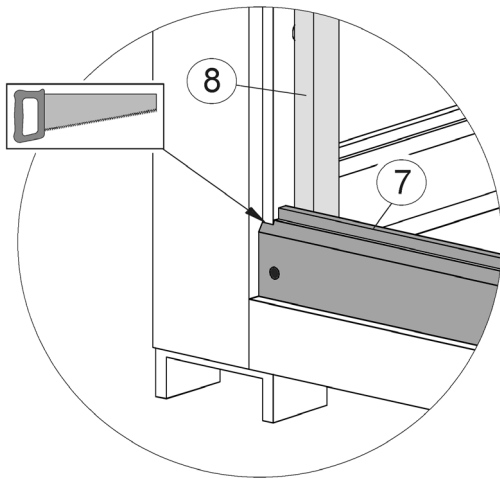
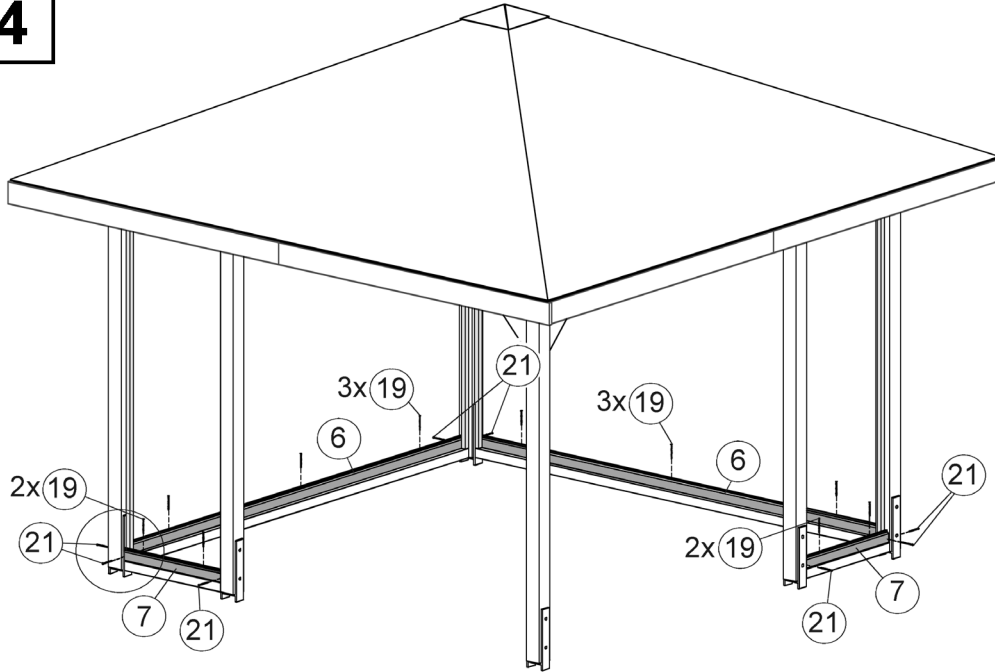

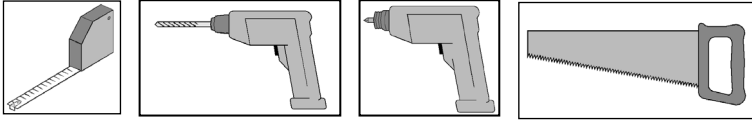

5

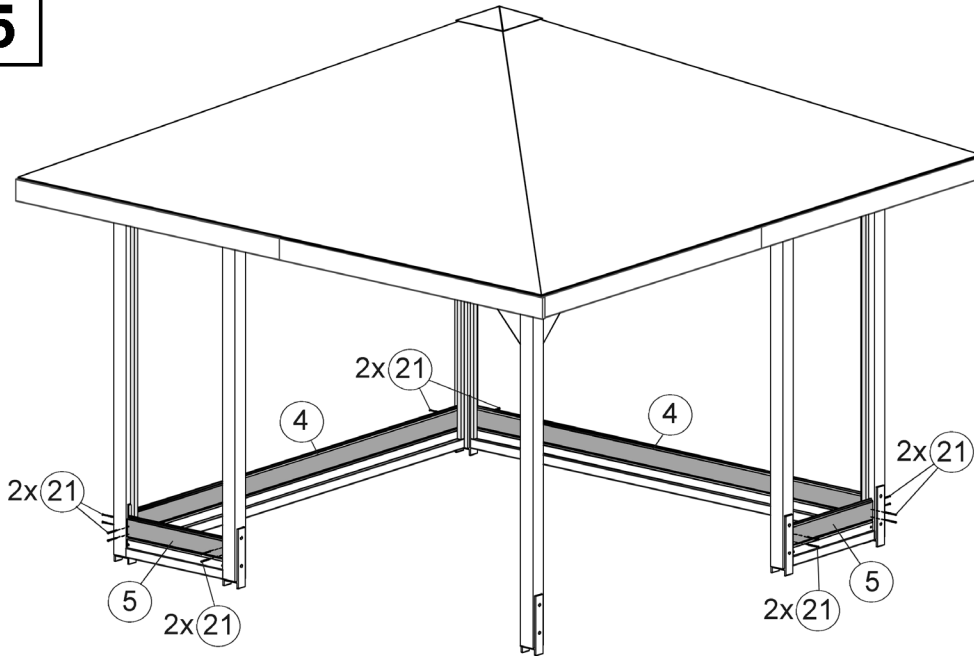

6

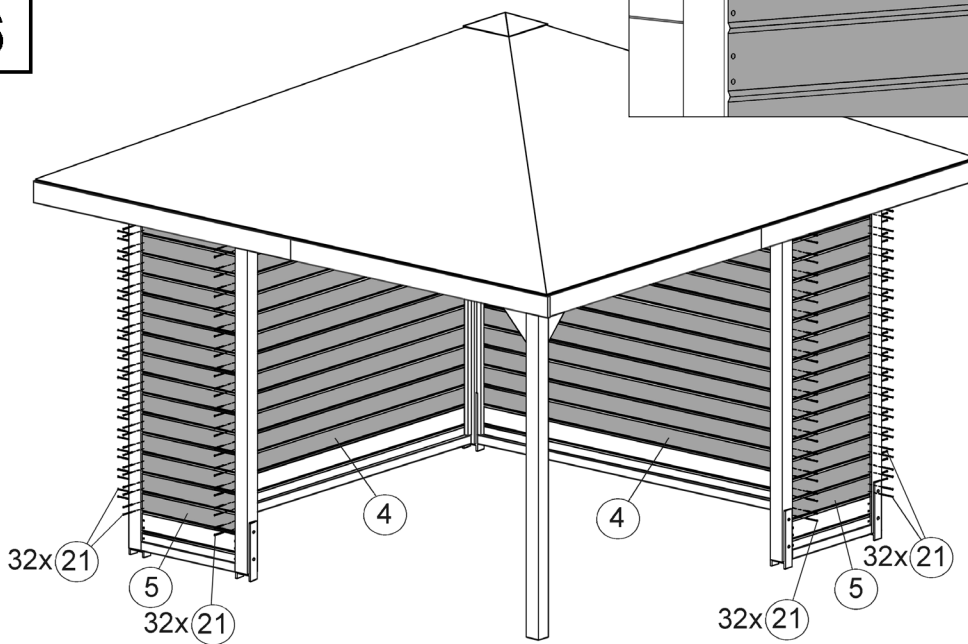

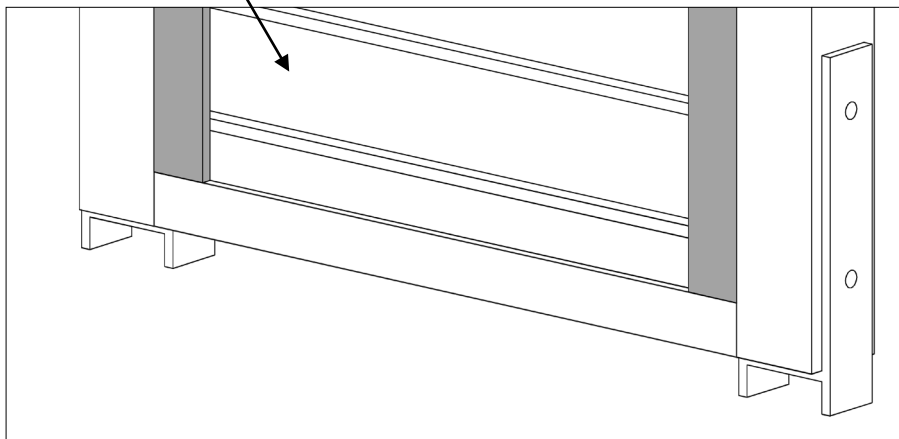
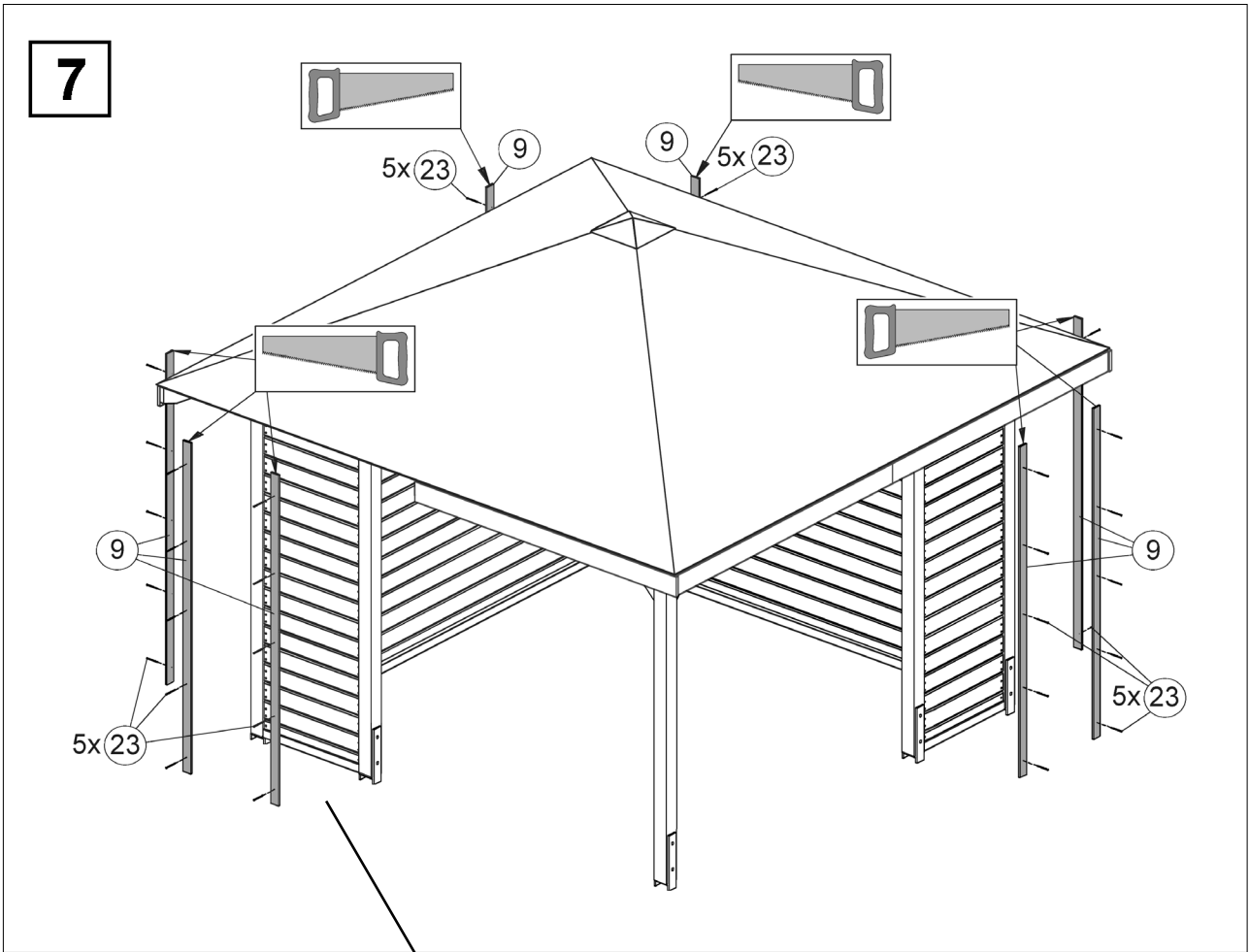
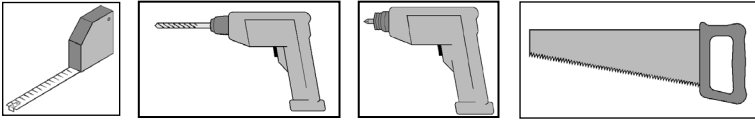

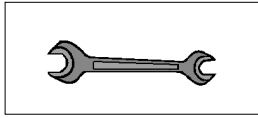
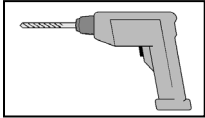
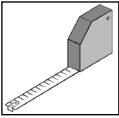

8

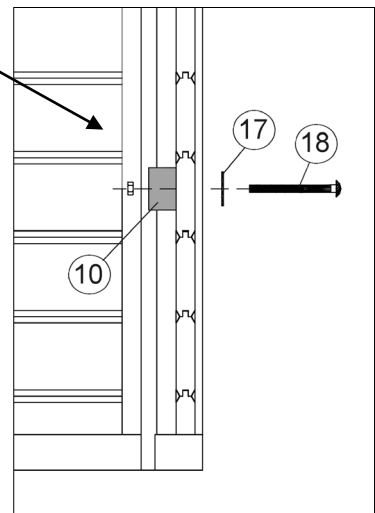
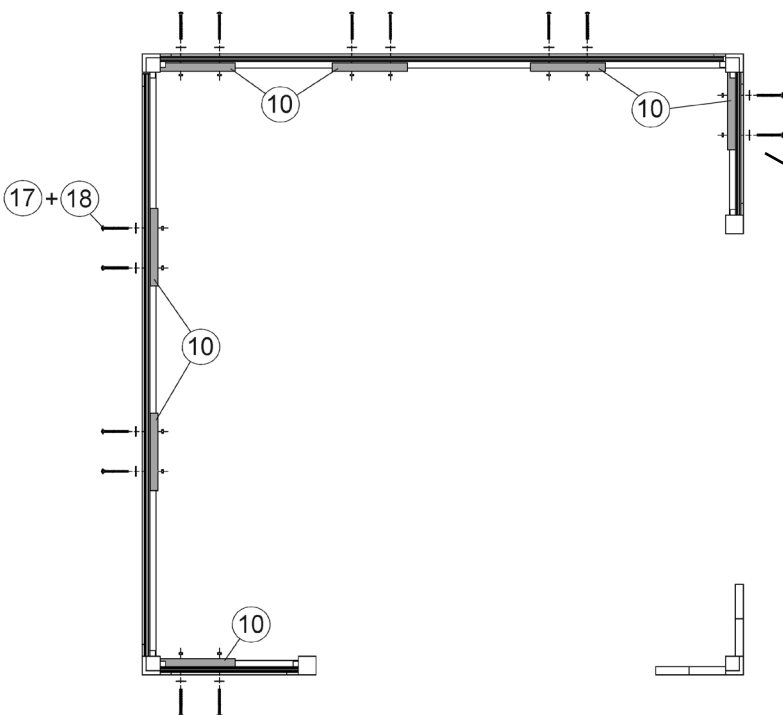
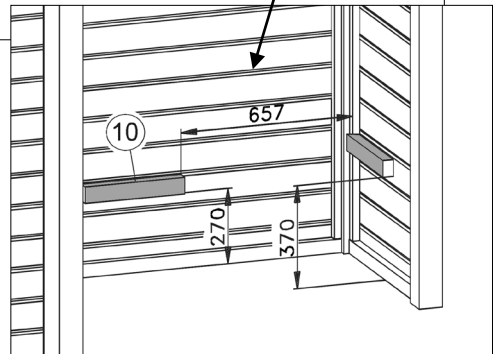
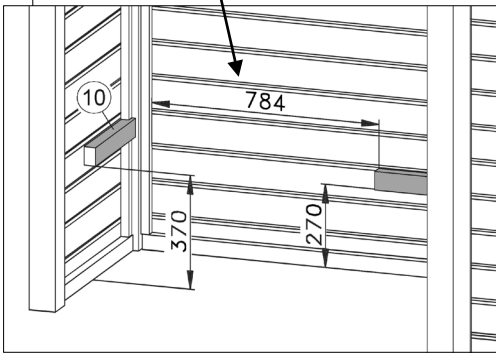
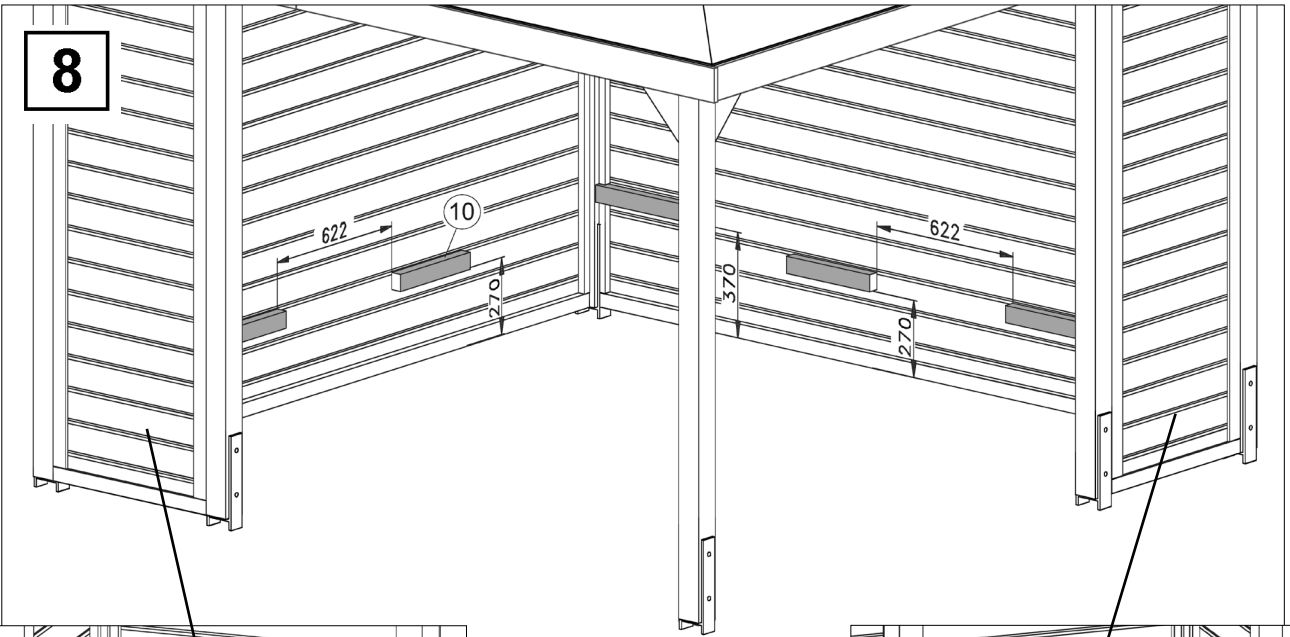

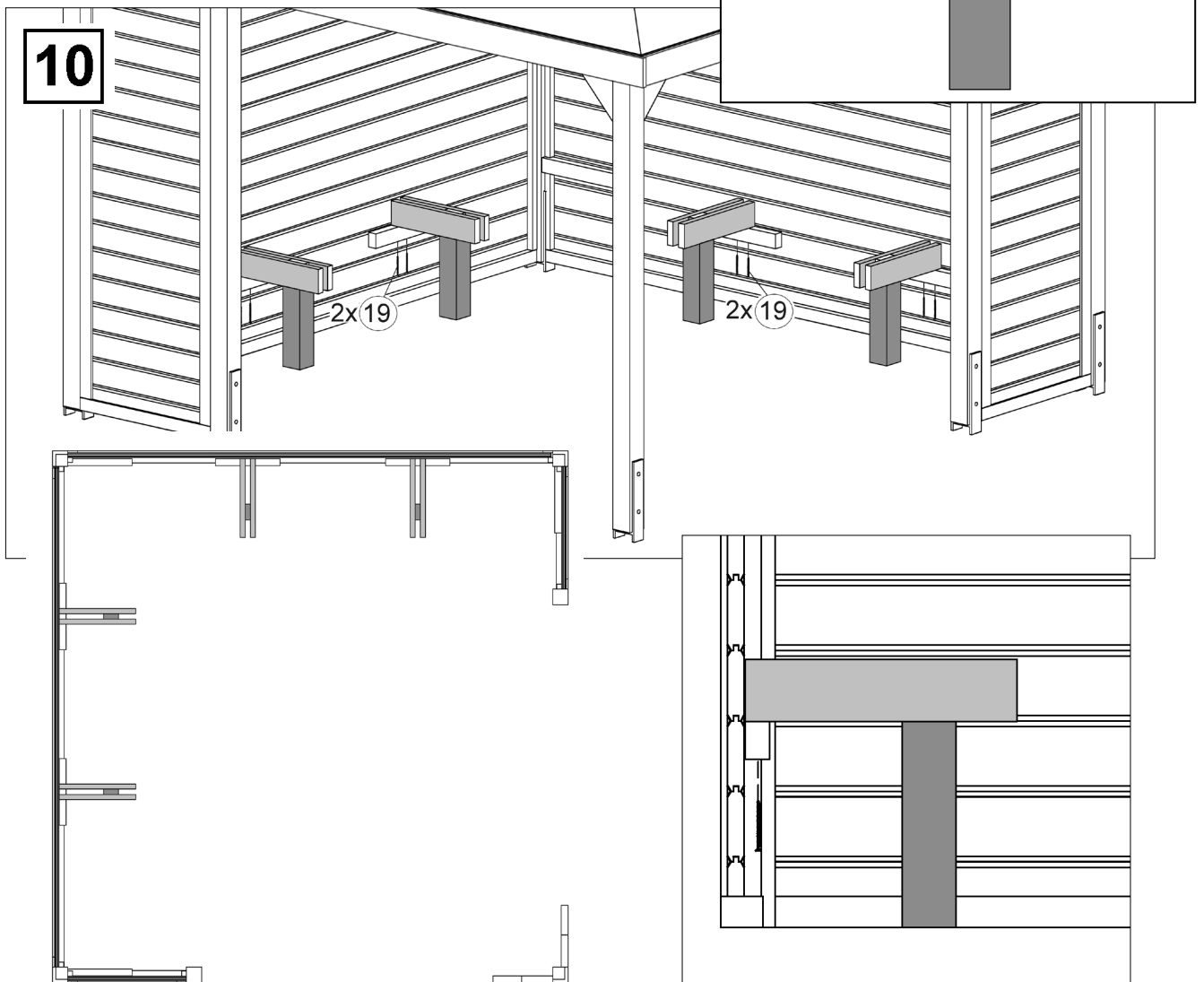
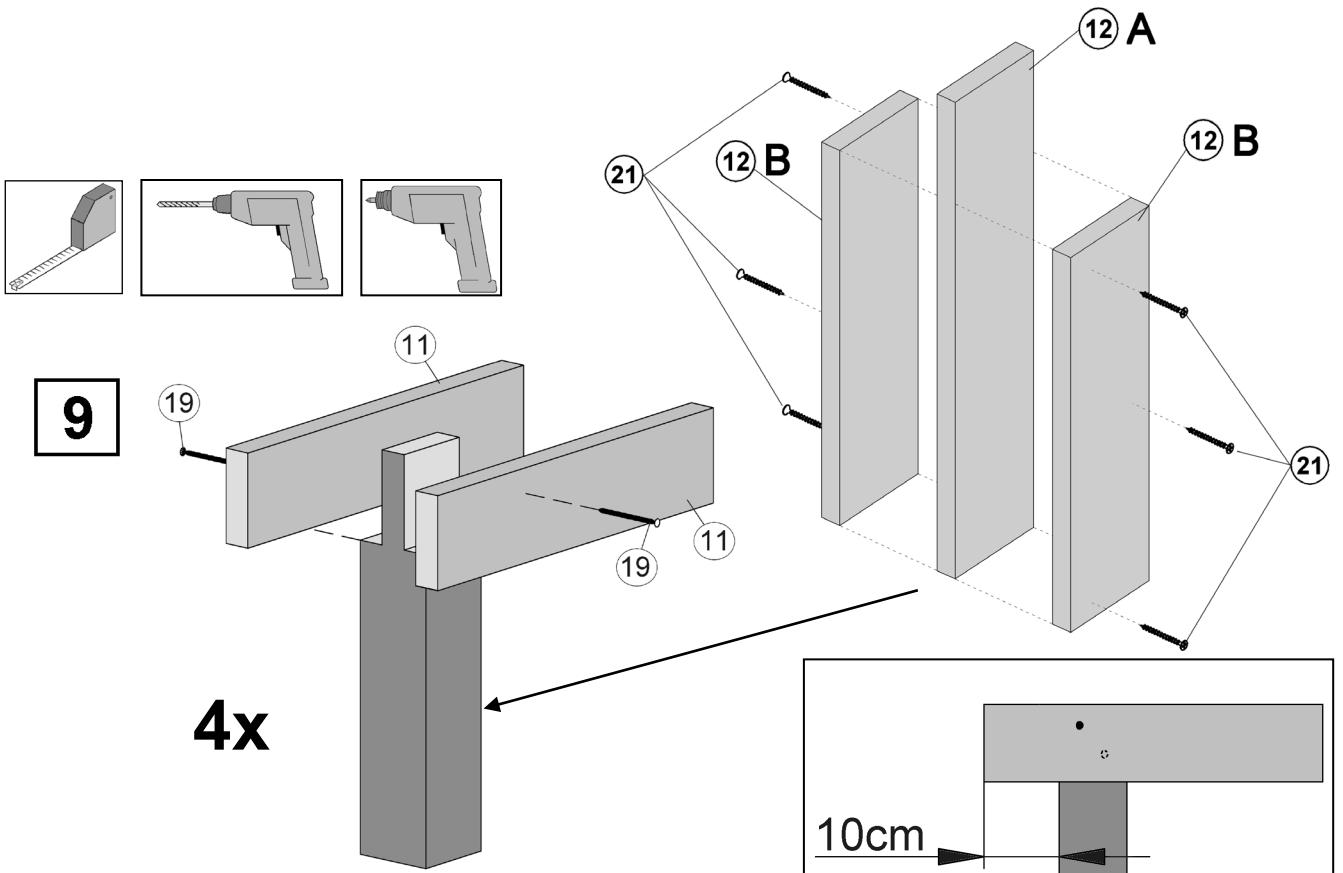

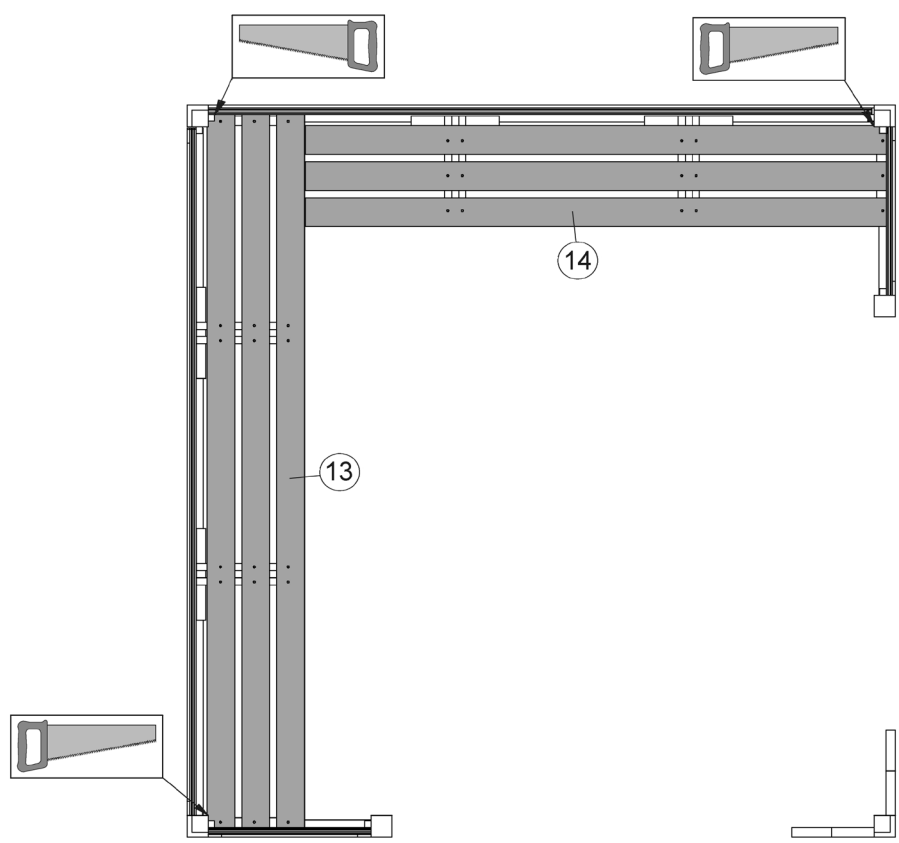
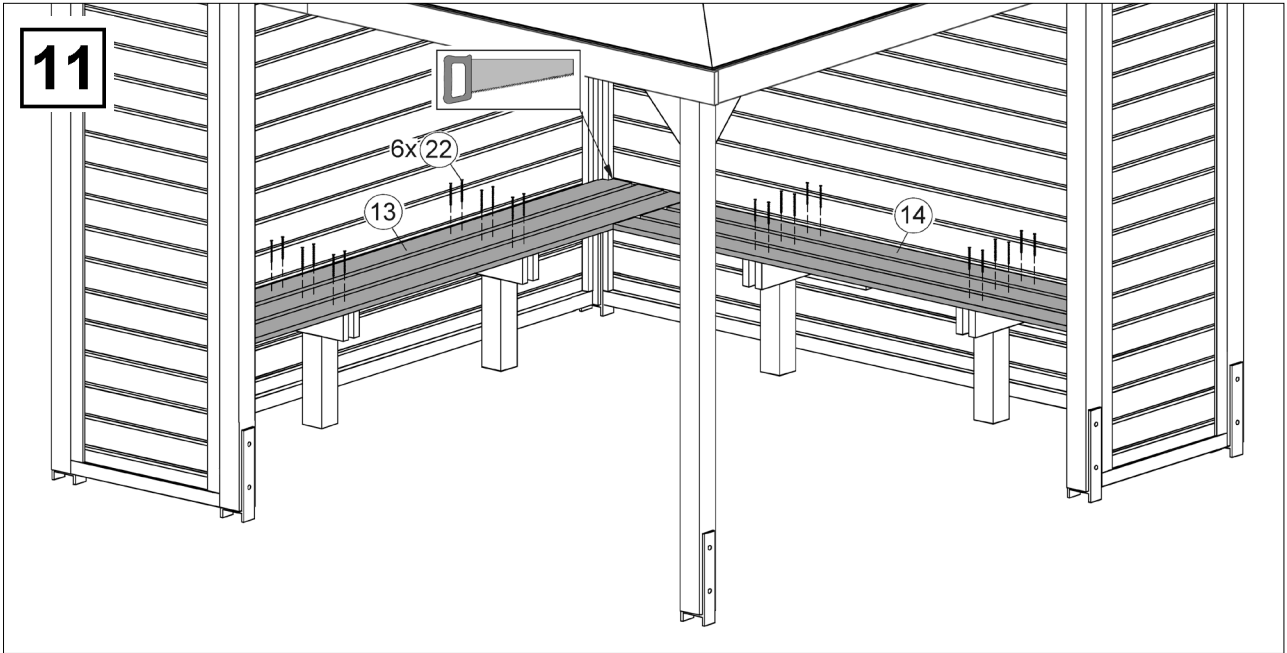
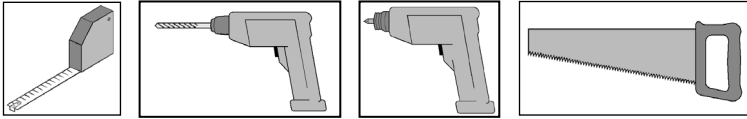

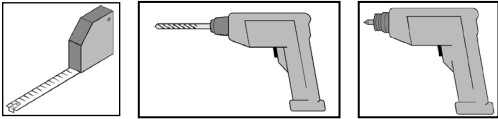

12

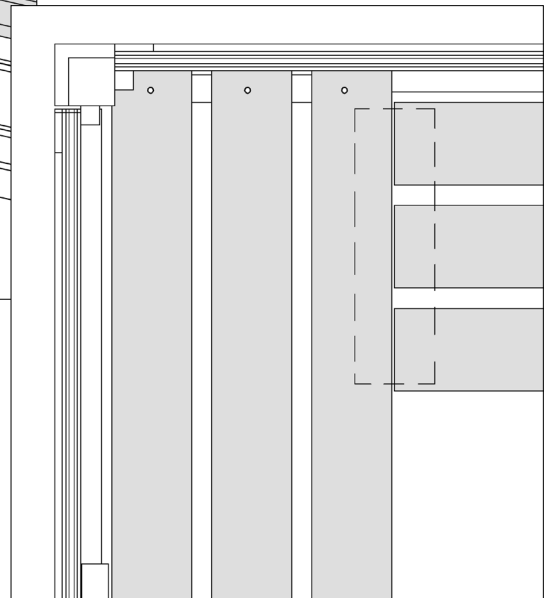
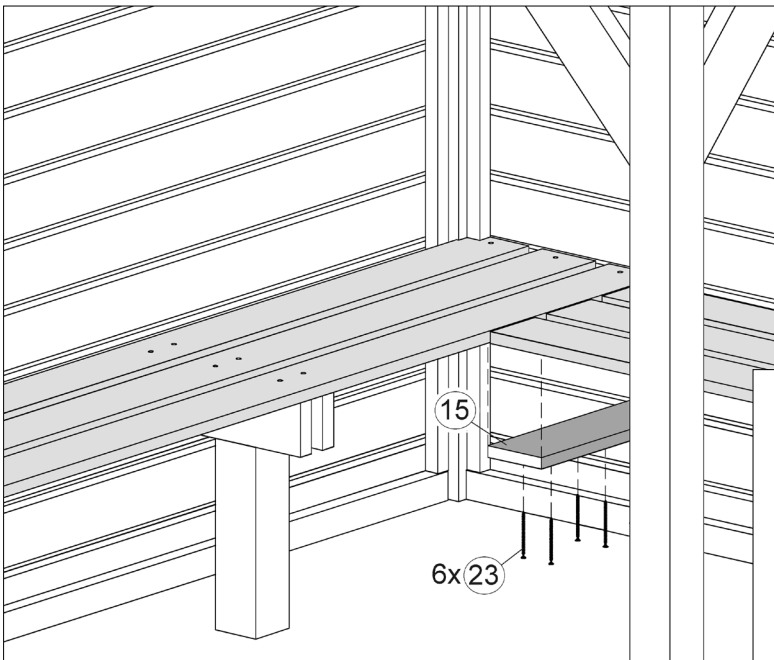

weka Holzbau GmbH,
Johannesstr. 16
D-17034 Neubrandenburg
Tel.: 0395 42908-0
Fax: 0395 42908-83
EMail: Info@weka-Holzbau.com

MA Art.-Nr.: 800.0286.05.55