

D-01

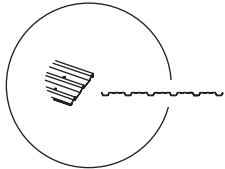

P6 x 1

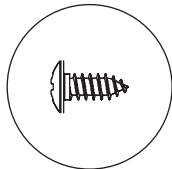

F1 x 12

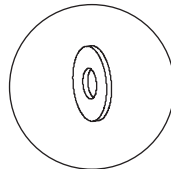

S3 x 12

1

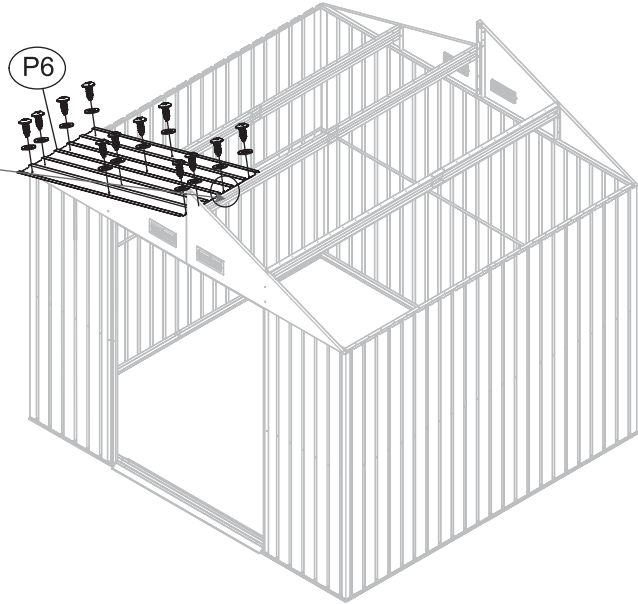
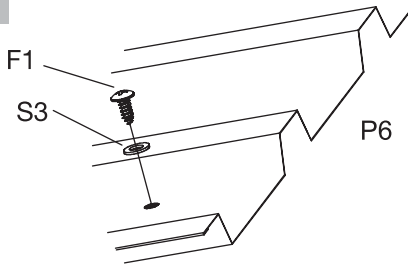

D-02

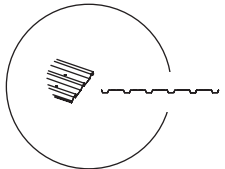

P8 x 2

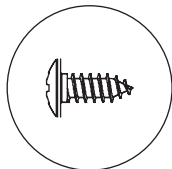

F1 x 12

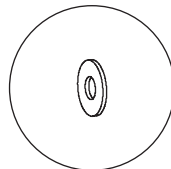

S3 x 12

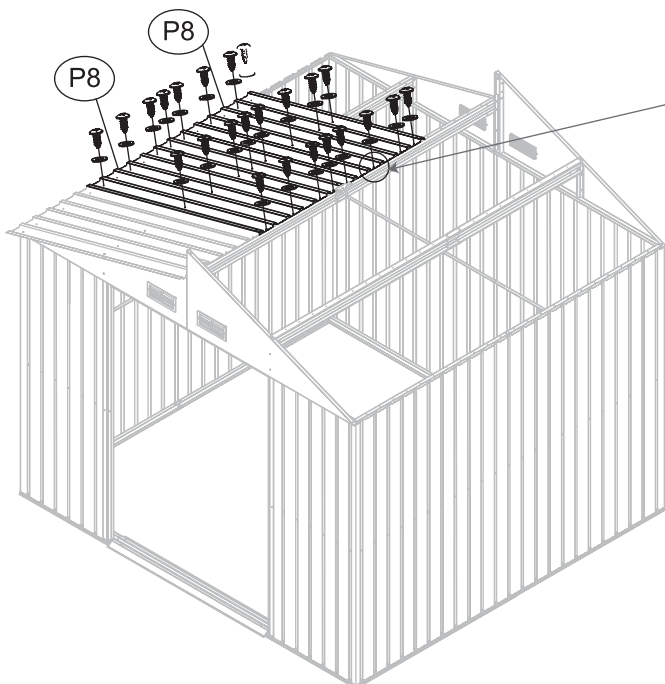
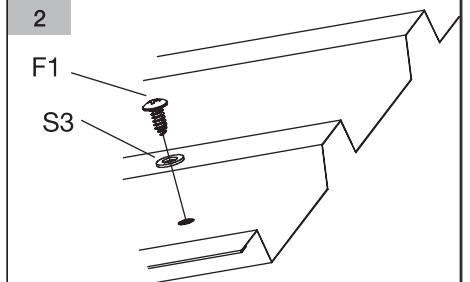
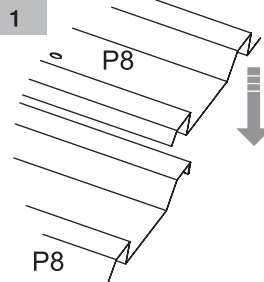

D-03

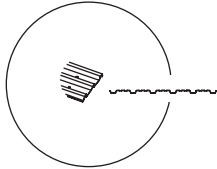

P5 x 1

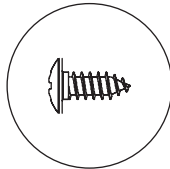

F1 x 12

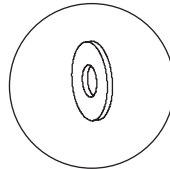

S3 x 12

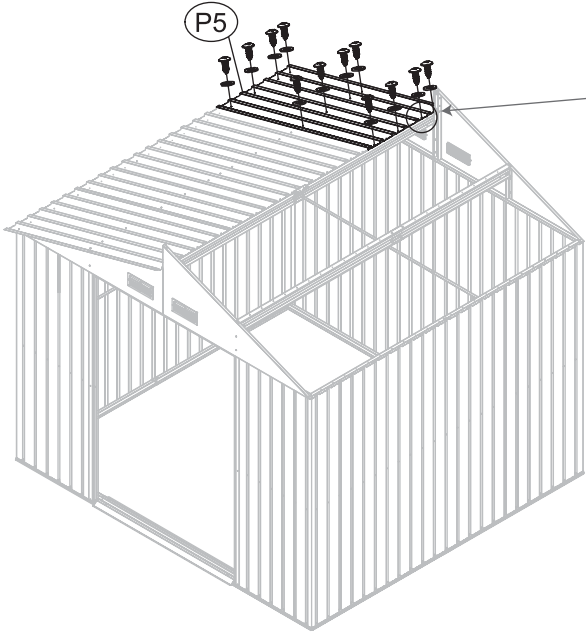
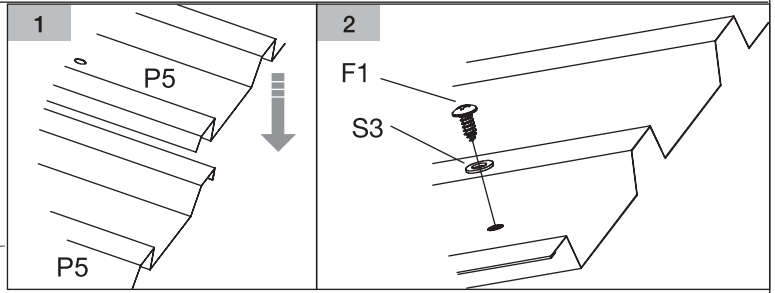

D-04

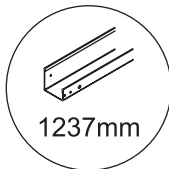

1237mm

C5 x 1

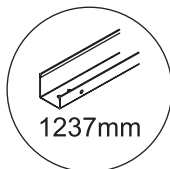

1237mm

C6 x 1

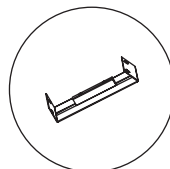

C10 x 1

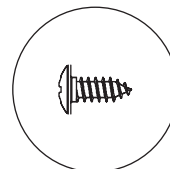

F1 x 8

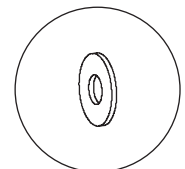

S3 x 8

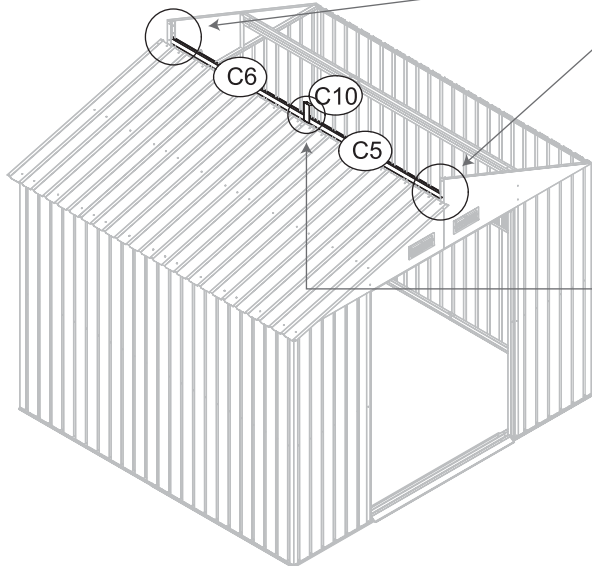
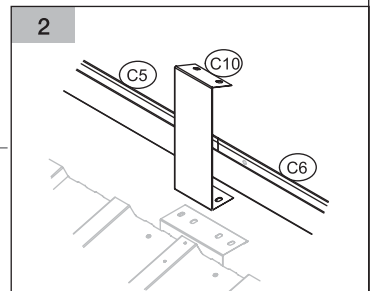
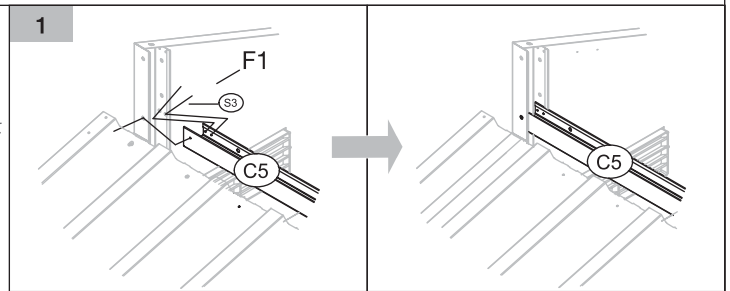

D-05

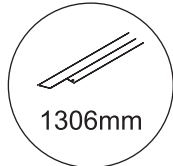

1306mm

C7 x 1

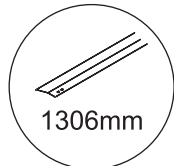

1306mm

C8 x 1

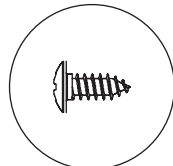

F1 x 14

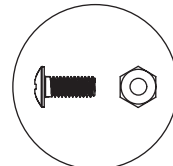

F2 x 4

1

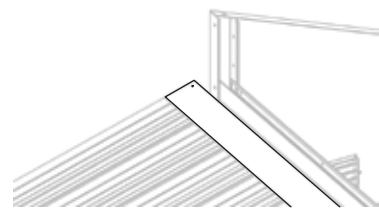
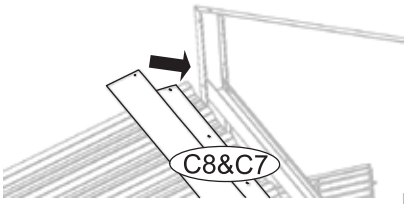

2

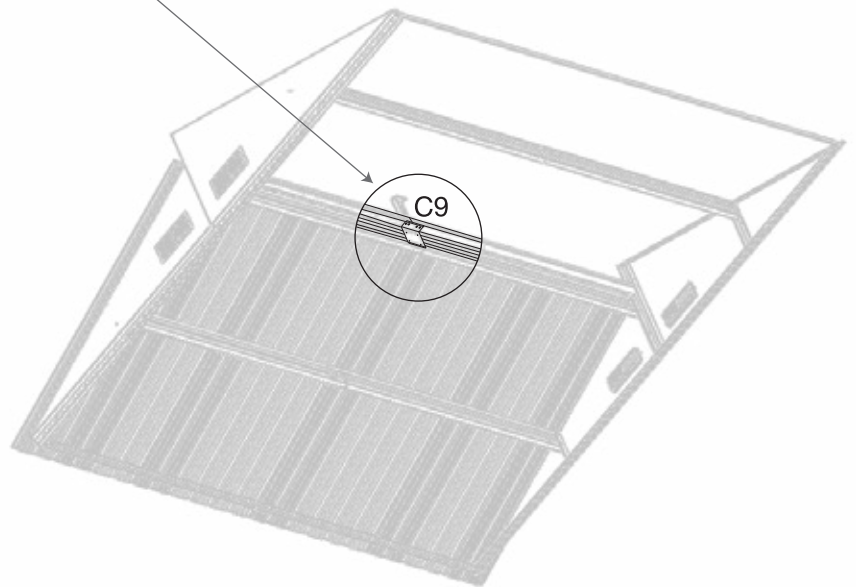
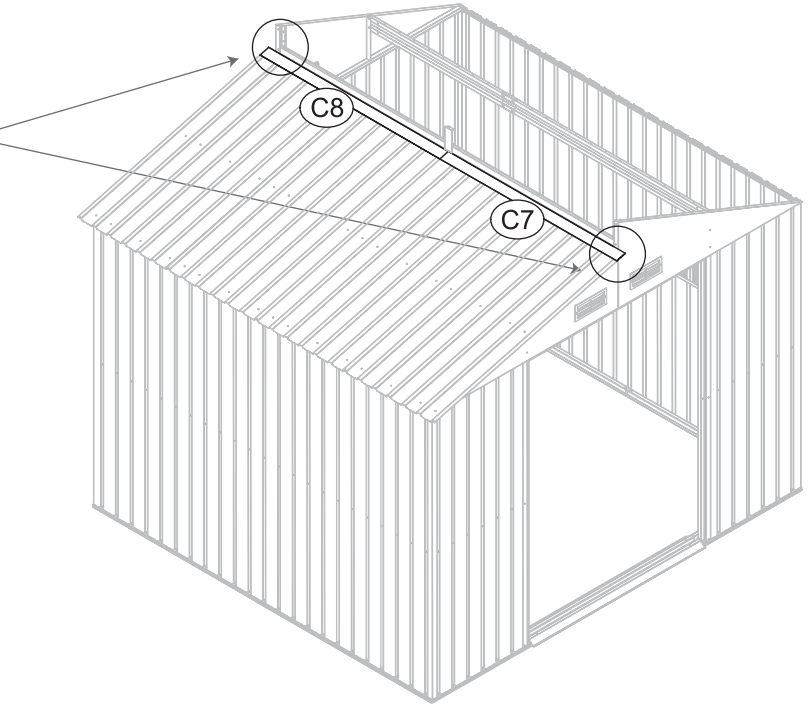
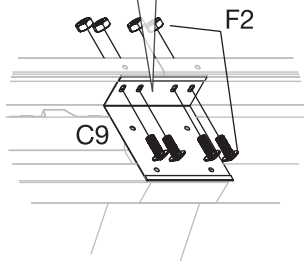
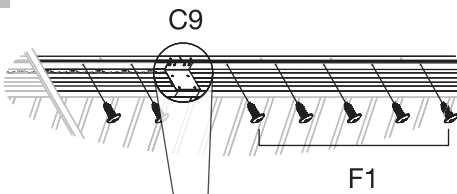

D-06

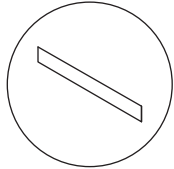

P7 x 2

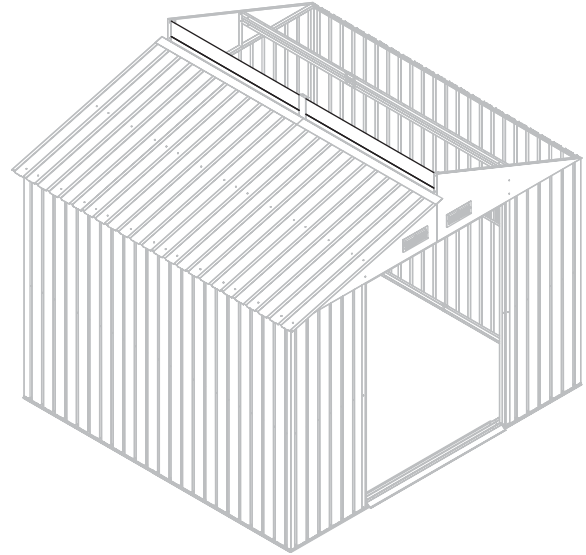
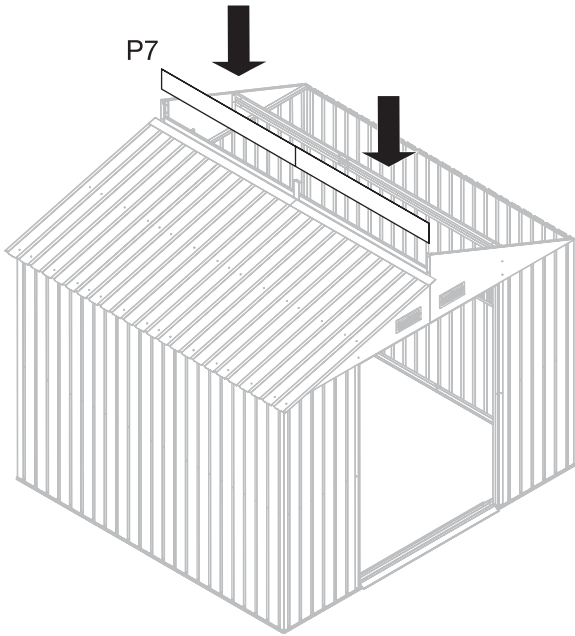

D-07

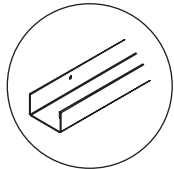

C12 x 2

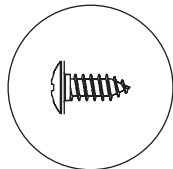

F1 x 10

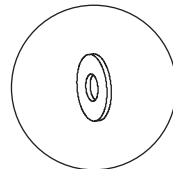

S3 x 10

1

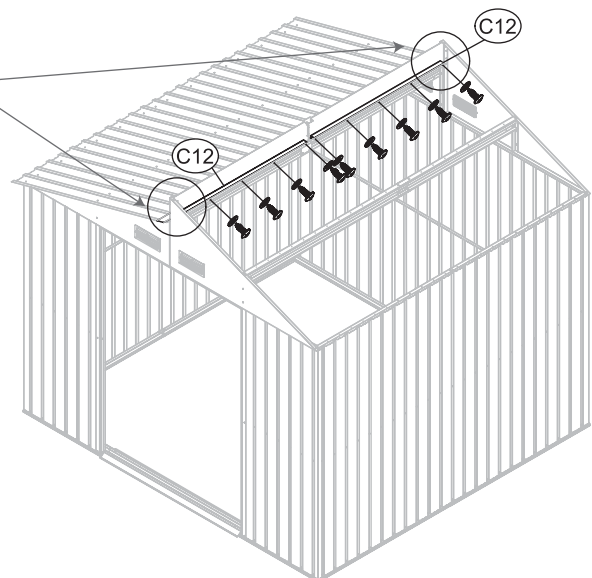
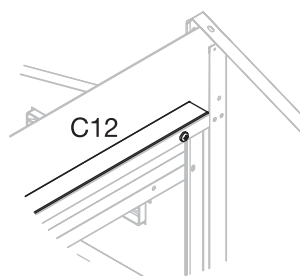
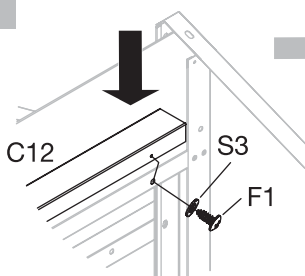

D-08

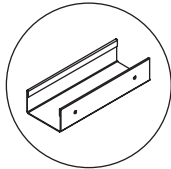

C14 x 2

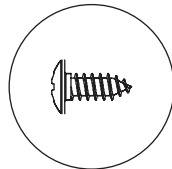

F1 x 8

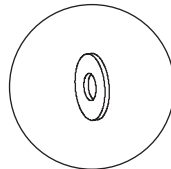

S3 x 8

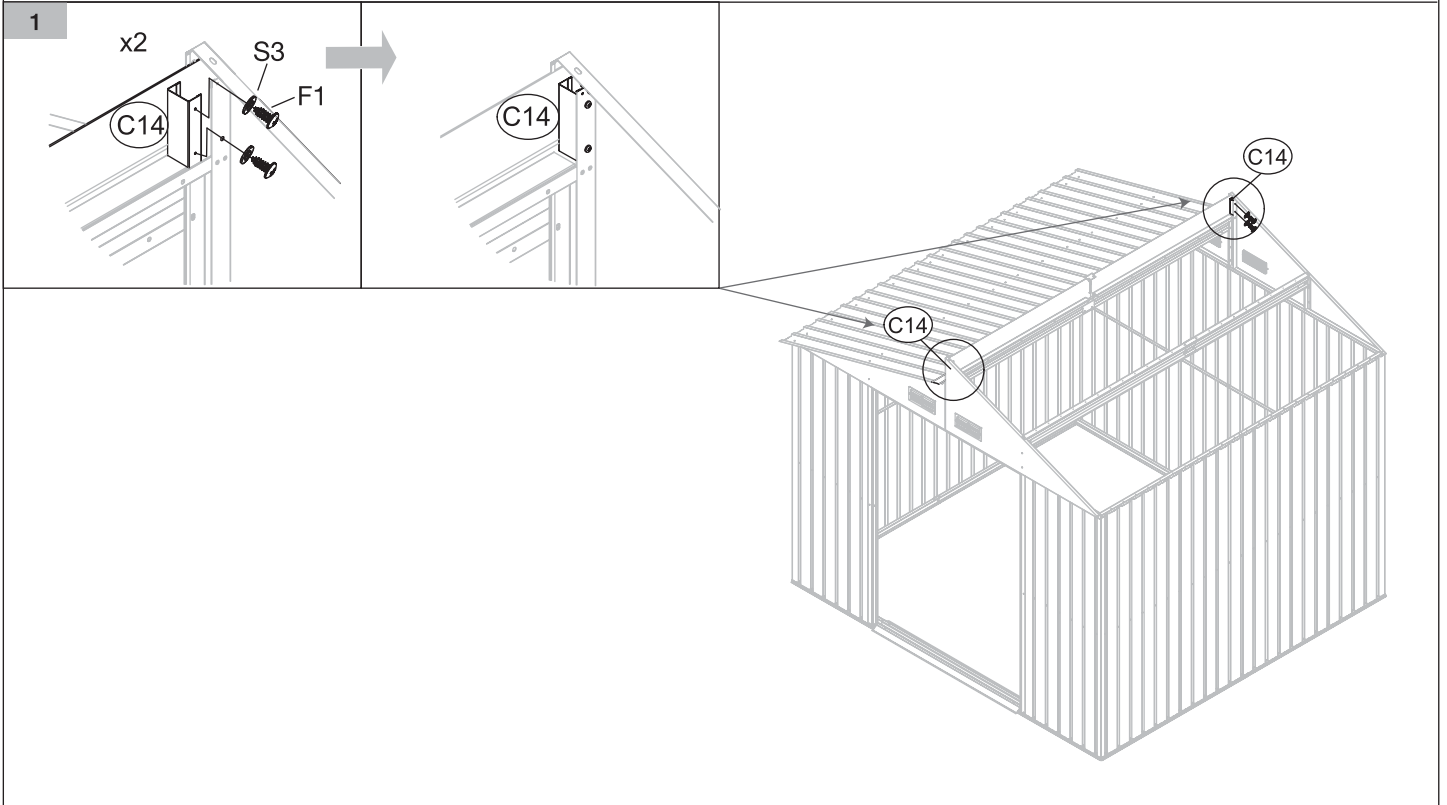

D-09

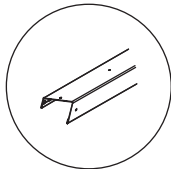

C4 x 1

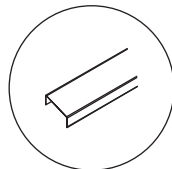

C13 x 1

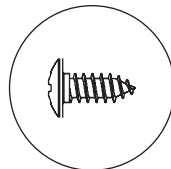

F1 x 7

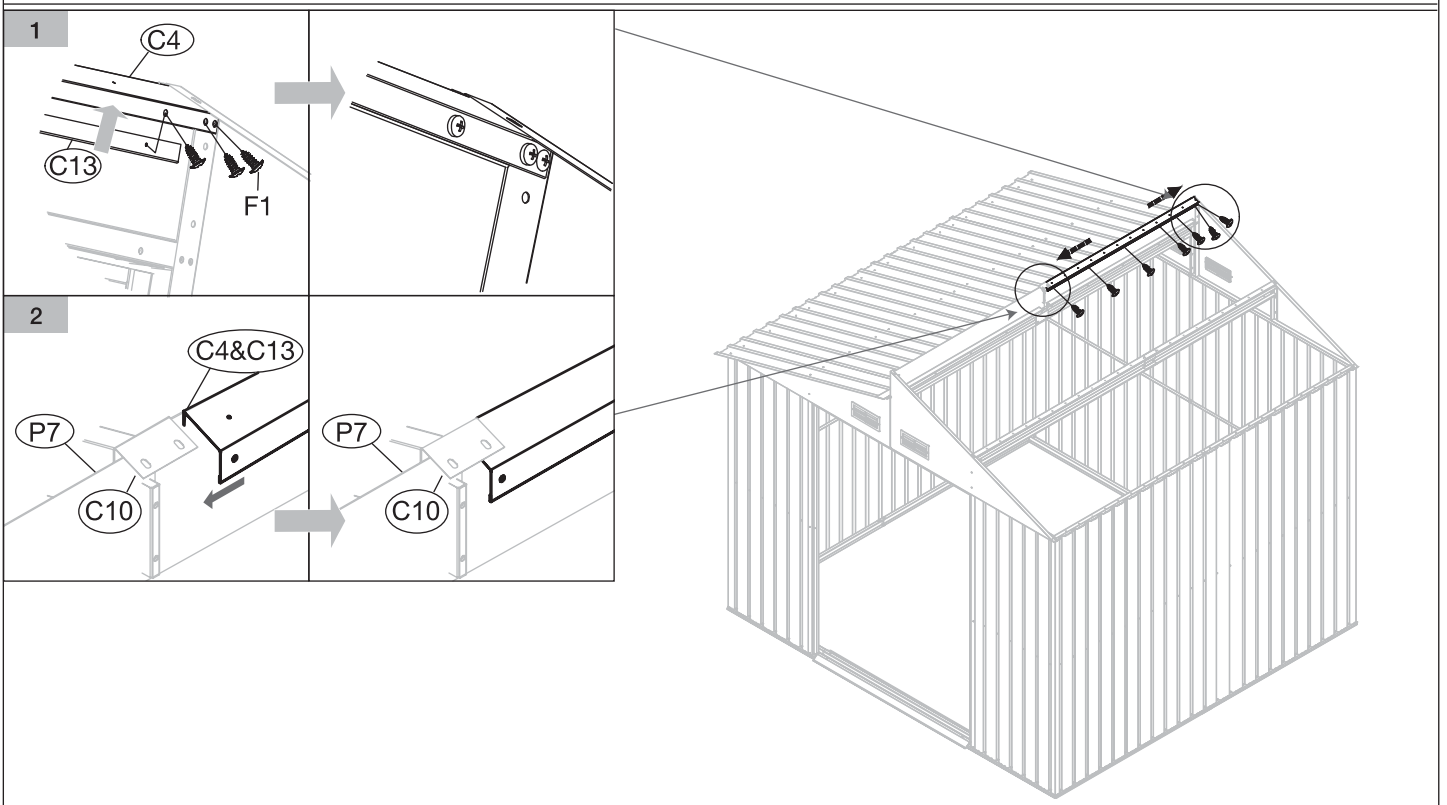

D-10

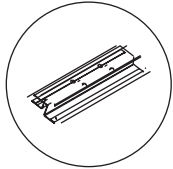

C11 x 1

1

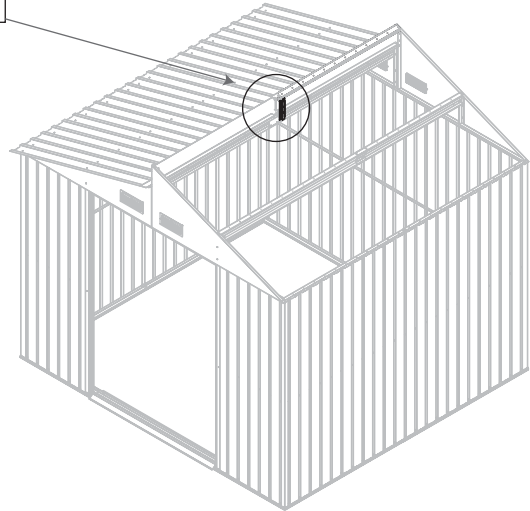
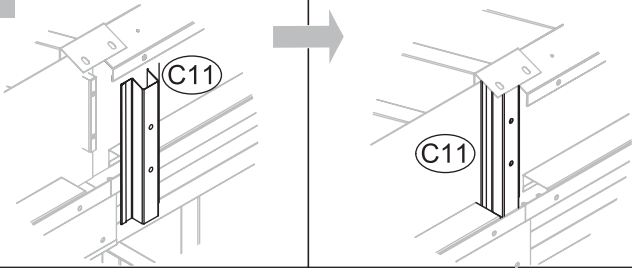

D-11

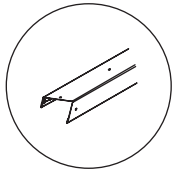

C3 x 1

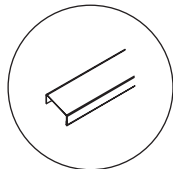

C13 x 1

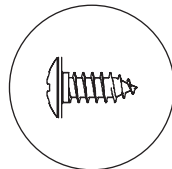

F1 x 7

1

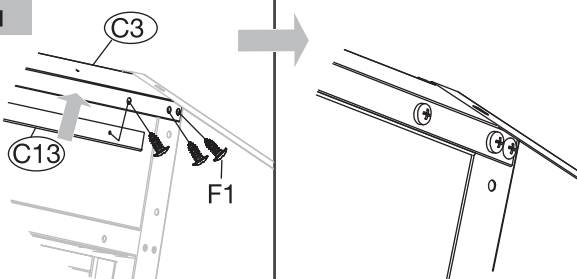

2

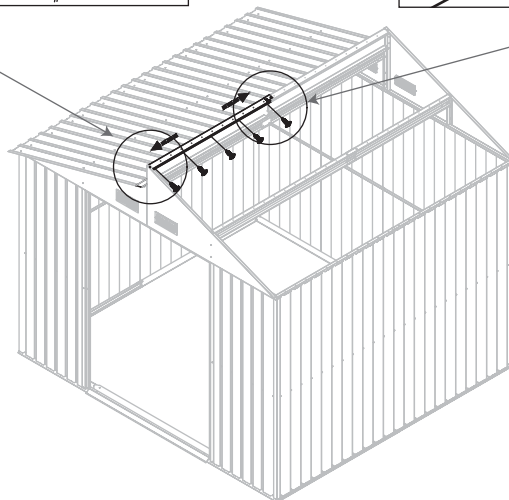
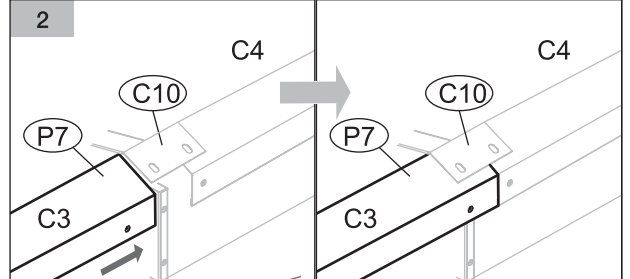

D-12

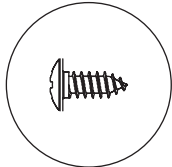

F1 x 2

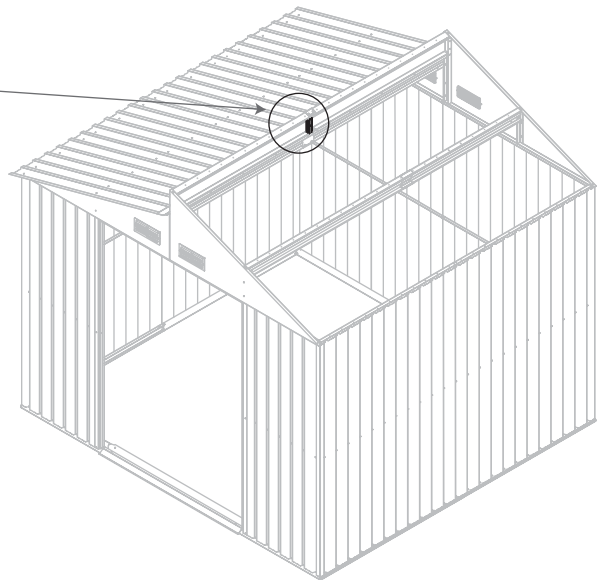
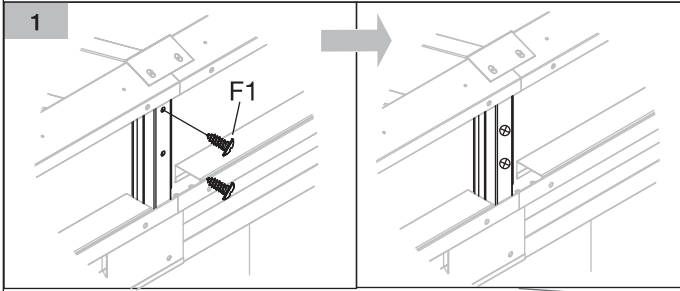

D-13

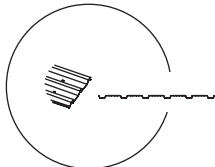

P15 x 1

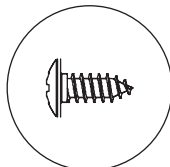

F1 x 12

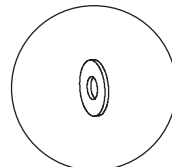

S3 x 12

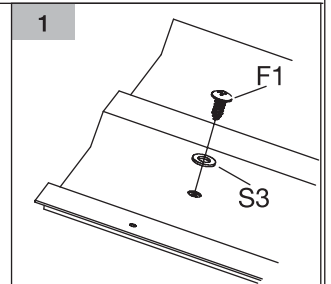
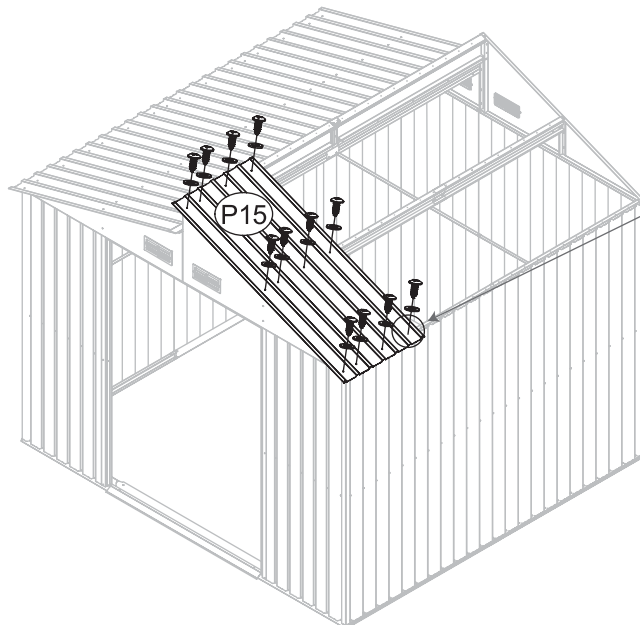

D-14

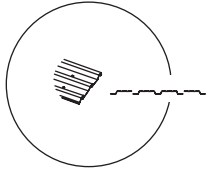

P18 x 2

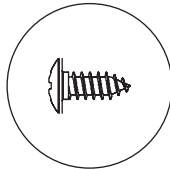

F1 x 24

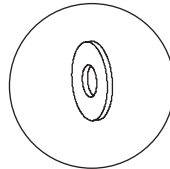

S3 x 24

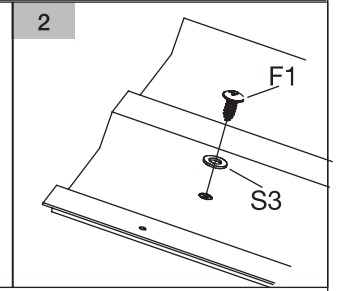
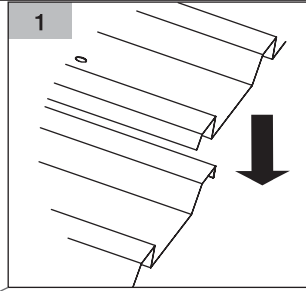
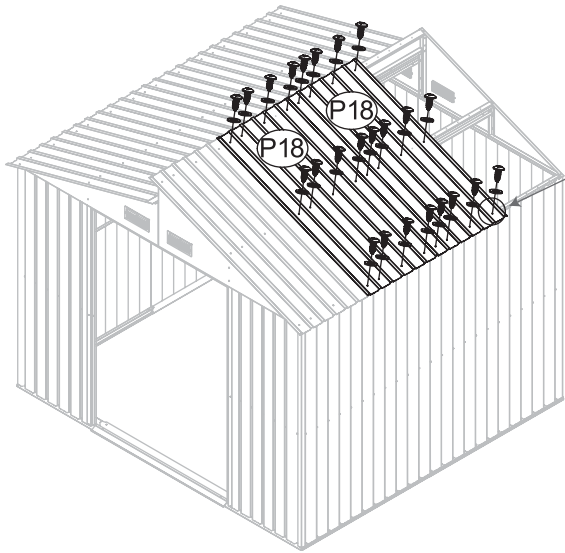

D-15

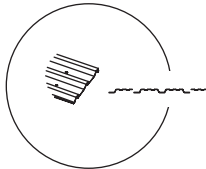

P15 x 1

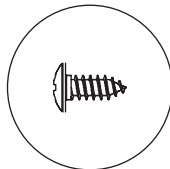

F1 x 12

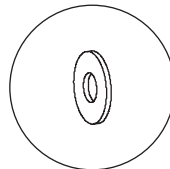

S3 x 12

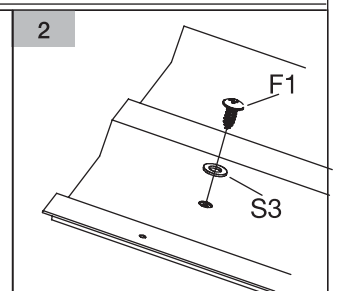
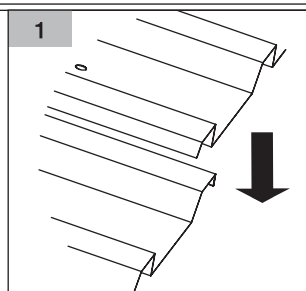
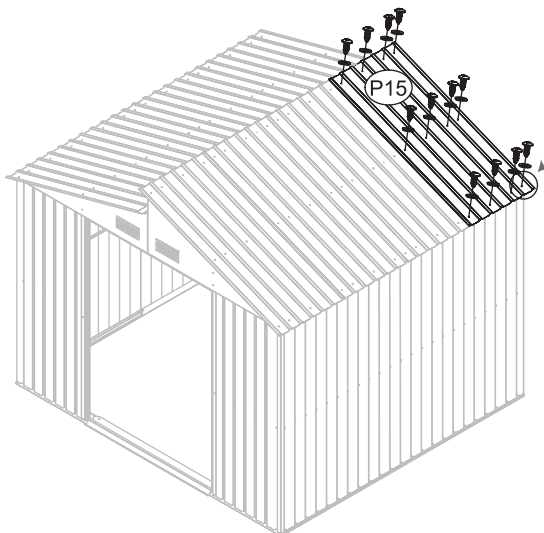

D-16

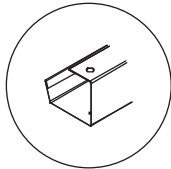

24-1 x 1

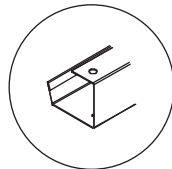

24-2 x 1

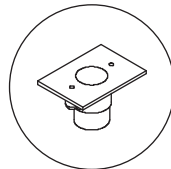

GS x 4

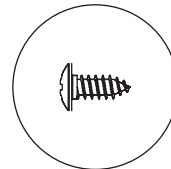

F1 x 8

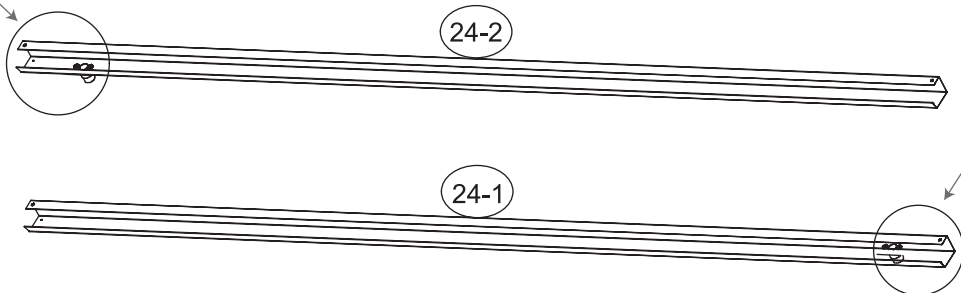
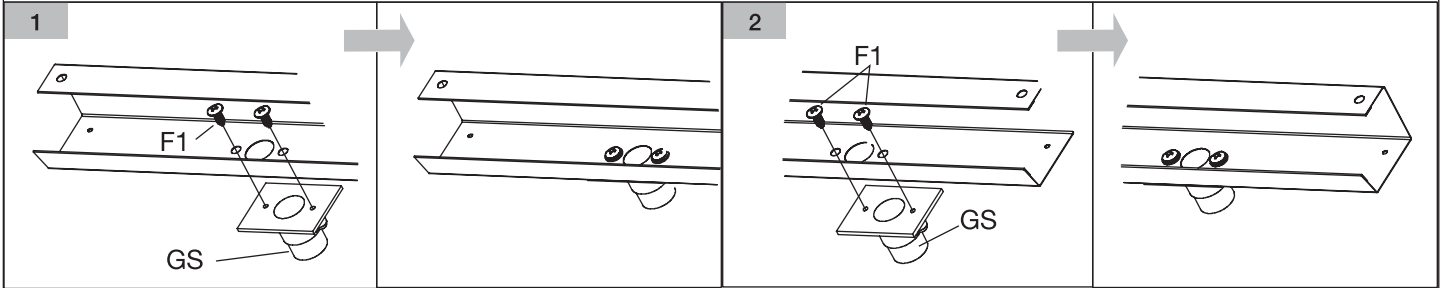

x2

D-17

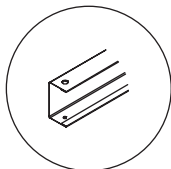

17 x 1

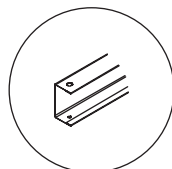

17_1 x 1

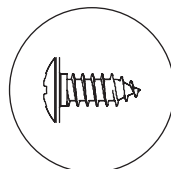

F1 x 15

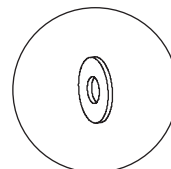

S3 x 15

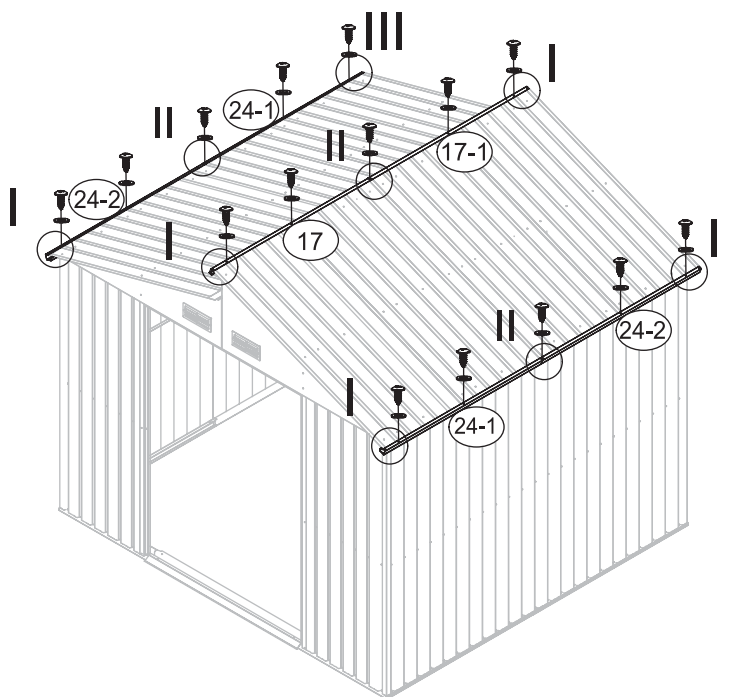
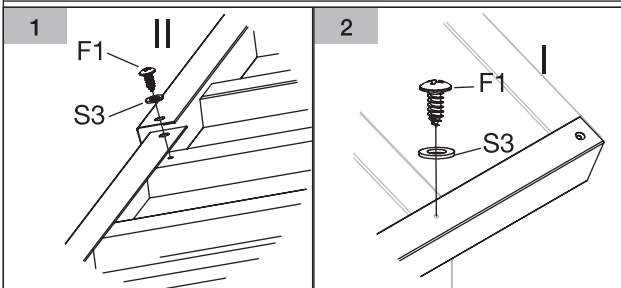

D-18

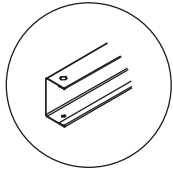

28 x 2

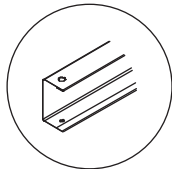

29 x 2

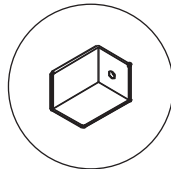

GC x 8

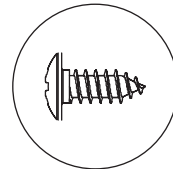

F1 x 12

